

Structural sections

to BS4: Part 1: 1993 and BS EN10056: 1999

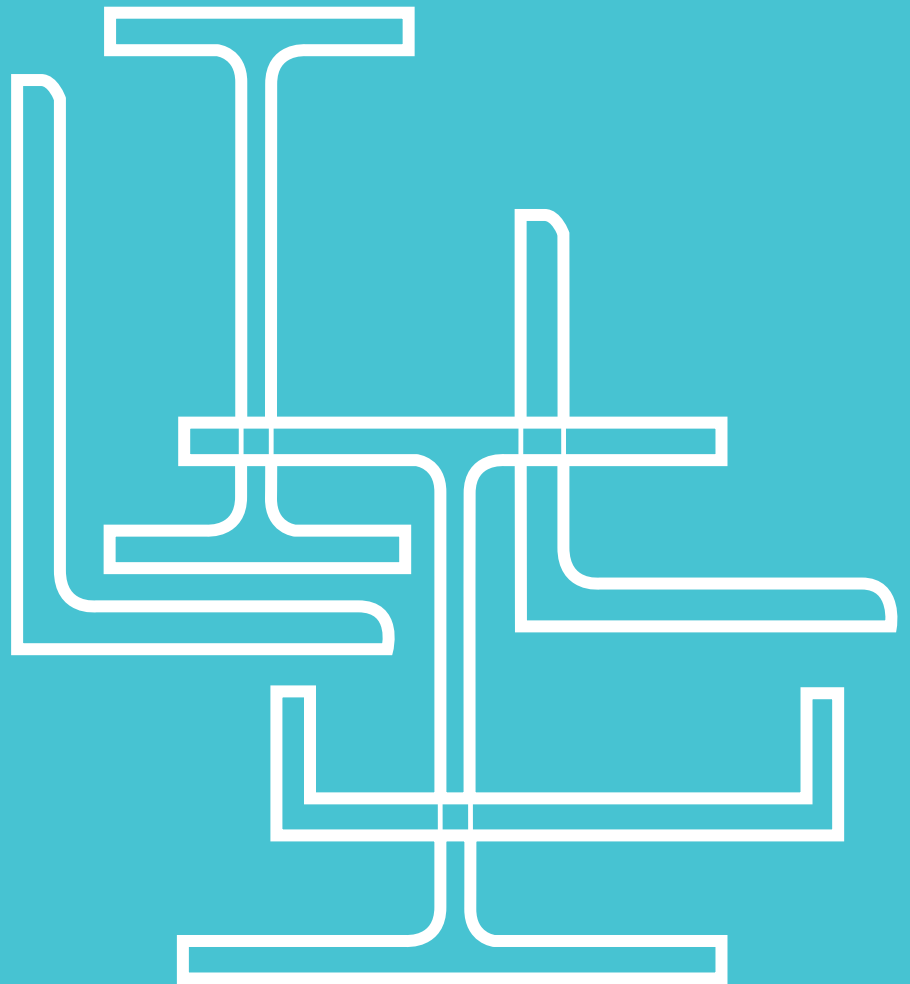

Universal beams

Dimensions and properties to BS 4: Part 1: 1993

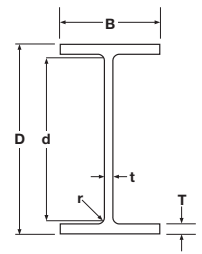

Designation Serial Size	Mass per metre kg/m	Depth of Section D mm	Width of Section B mm	Thickness of Web t mm	Thickness of Flange T mm	Root Radius r mm	Depth between fillets d mm	Ratios for Local Buckling		Second Moment of Area	
								Flange B/2T	Web d/t	Axis x-x cm ⁴	Axis y-y cm ⁴
† 1016 x 305 x 487	486.6	1036.1	308.5	30.0	54.1	30.0	867.9	2.85	28.9	1021400	26720
† 1016 x 305 x 437	436.9	1025.9	305.4	26.9	49.0	30.0	867.9	3.12	32.3	909900	23450
† 1016 x 305 x 393	392.7	1016.0	303.0	24.4	43.9	30.0	868.2	3.45	35.6	807700	20500
† 1016 x 305 x 349	349.4	1008.1	302.0	21.1	40.0	30.0	868.1	3.78	41.1	723100	18460
† 1016 x 305 x 314	314.3	1000.0	300.0	19.1	35.9	30.0	868.2	4.18	45.5	644200	16230
† 1016 x 305 x 272	272.3	990.1	300.0	16.5	31.0	30.0	868.1	4.84	52.6	554000	14000
† 1016 x 305 x 249	248.7	980.2	300.0	16.5	26.0	30.0	868.2	5.77	52.6	481300	11750
† 1016 x 305 x 222	222.0	970.3	300.0	16.0	21.1	30.0	868.1	7.11	54.3	408000	9546
914 x 419 x 388	388.0	921.0	420.5	21.4	36.6	24.1	799.6	5.74	37.4	719600	45440
914 x 419 x 343	343.3	911.8	418.5	19.4	32.0	24.1	799.6	6.54	41.2	625800	39160
914 x 305 x 289	289.1	926.6	307.7	19.5	32.0	19.1	824.4	4.81	42.3	504200	15600
914 x 305 x 253	253.4	918.4	305.5	17.3	27.9	19.1	824.4	5.47	47.7	436300	13300
914 x 305 x 224	224.2	910.4	304.1	15.9	23.9	19.1	824.4	6.36	51.8	376400	11240
914 x 305 x 201	200.9	903.0	303.3	15.1	20.2	19.1	824.4	7.51	54.6	325300	9423
838 x 292 x 226	226.5	850.9	293.8	16.1	26.8	17.8	761.7	5.48	47.3	339700	11360
838 x 292 x 194	193.8	840.7	292.4	14.7	21.7	17.8	761.7	6.74	51.8	279200	9066
838 x 292 x 176	175.9	834.9	291.7	14.0	18.8	17.8	761.7	7.76	54.4	246000	7799
762 x 267 x 197	196.8	769.8	268.0	15.6	25.4	16.5	686.0	5.28	44.0	240000	8175
762 x 267 x 173	173.0	762.2	266.7	14.3	21.6	16.5	686.0	6.17	48.0	205300	6850
762 x 267 x 147	146.9	754.0	265.2	12.8	17.5	16.5	686.0	7.58	53.6	168500	5455
762 x 267 x 134	133.9	750.0	264.4	12.0	15.5	16.5	686.0	8.53	57.2	150700	4788
686 x 254 x 170	170.2	692.9	255.8	14.5	23.7	15.2	615.1	5.40	42.4	170300	6630
686 x 254 x 152	152.4	687.5	254.5	13.2	21.0	15.2	615.1	6.06	46.6	150400	5784
686 x 254 x 140	140.1	683.5	253.7	12.4	19.0	15.2	615.1	6.68	49.6	136300	5183
686 x 254 x 125	125.2	677.9	253.0	11.7	16.2	15.2	615.1	7.81	52.6	118000	4383
610 x 305 x 238	238.1	635.8	311.4	18.4	31.4	16.5	540.0	4.96	29.3	209500	15840
610 x 305 x 179	179.0	620.2	307.1	14.1	23.6	16.5	540.0	6.51	38.3	153000	11410
610 x 305 x 149	149.2	612.4	304.8	11.8	19.7	16.5	540.0	7.74	45.8	125900	9308
610 x 229 x 140	139.9	617.2	230.2	13.1	22.1	12.7	547.6	5.21	41.8	111800	4505
610 x 229 x 125	125.1	612.2	229.0	11.9	19.6	12.7	547.6	5.84	46.0	98610	3932
610 x 229 x 113	113.0	607.6	228.2	11.1	17.3	12.7	547.6	6.60	49.3	87320	3434
610 x 229 x 101	101.2	602.6	227.6	10.5	14.8	12.7	547.6	7.69	52.2	75780	2915
533 x 210 x 122	122.0	544.5	211.9	12.7	21.3	12.7	476.5	4.97	37.5	76040	3388
533 x 210 x 109	109.0	539.5	210.8	11.6	18.8	12.7	476.5	5.61	41.1	66820	2943
533 x 210 x 101	101.0	536.7	210.0	10.8	17.4	12.7	476.5	6.03	44.1	61520	2692
533 x 210 x 92	92.1	533.1	209.3	10.1	15.6	12.7	476.5	6.71	47.2	55230	2389
533 x 210 x 82	82.2	528.3	208.8	9.6	13.2	12.7	476.5	7.91	49.6	47540	2007
457 x 191 x 98	98.3	467.2	192.8	11.4	19.6	10.2	407.6	4.92	35.8	45730	2347
457 x 191 x 89	89.3	463.4	191.9	10.5	17.7	10.2	407.6	5.42	38.8	41020	2089
457 x 191 x 82	82.0	460.0	191.3	9.9	16.0	10.2	407.6	5.98	41.2	37050	1871
457 x 191 x 74	74.3	457.0	190.4	9.0	14.5	10.2	407.6	6.57	45.3	33320	1671
457 x 191 x 67	67.1	453.4	189.9	8.5	12.7	10.2	407.6	7.48	48.0	29380	1452

† These dimensions are in addition to our standard range to BS4 specifications

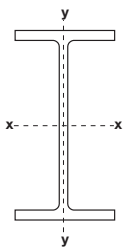

Universal beams

Dimensions and properties to BS 4: Part 1: 1993

Radius of Gyration		Elastic Modulus		Plastic Modulus		Buckling Parameter u	Torsional Index x	Warping Constant H dm ⁶	Torsional Constant J cm ⁴	Area of Section cm ²	Mass per metre kg/m	Designation	
Axis x-x cm	Axis y-y cm	Axis x-x cm ³	Axis y-y cm ³	Axis x-x cm ³	Axis y-y cm ³							Serial Size	
40.6	6.57	19720	1732	23200	2800	0.867	21.1	64.4	4299	620	486.6	1016 x 305 x 487	
40.4	6.49	17740	1535	20760	2469	0.868	23.1	55.9	3185	557	436.9	1016 x 305 x 437	
40.2	6.40	15900	1353	18540	2168	0.868	25.5	48.4	2330	500	392.7	1016 x 305 x 393	
40.3	6.44	14350	1223	16590	1941	0.872	27.9	43.3	1718	445	349.4	1016 x 305 x 349	
40.1	6.37	12880	1082	14850	1713	0.872	30.7	37.7	1264	400	314.3	1016 x 305 x 314	
40.0	6.35	11190	934	12830	1470	0.873	35.0	32.2	835	347	272.3	1016 x 305 x 272	
39.0	6.09	9821	784	11350	1245	0.861	39.9	26.8	582	317	248.7	1016 x 305 x 249	
38.0	5.81	8409	636	9807	1020	0.850	45.7	21.5	390	283	222.0	1016 x 305 x 222	
38.2	9.59	15630	2161	17670	3341	0.885	26.7	88.9	1734	494	388.0	914 x 419 x 388	
37.8	9.46	13730	1871	15480	2890	0.883	30.1	75.8	1193	437	343.3	914 x 419 x 343	
37.0	6.51	10880	1014	12570	1601	0.867	31.9	31.2	926	368	289.1	914 x 305 x 289	
36.8	6.42	9501	871	10940	1371	0.866	36.2	26.4	626	323	253.4	914 x 305 x 253	
36.3	6.27	8269	739	9535	1163	0.861	41.3	22.1	422	286	224.2	914 x 305 x 224	
35.7	6.07	7204	621	8351	982	0.854	46.8	18.4	291	256	200.9	914 x 305 x 201	
34.3	6.27	7985	773	9155	1212	0.870	35.0	19.3	514	289	226.5	838 x 292 x 226	
33.6	6.06	6641	620	7640	974	0.862	41.6	15.2	306	247	193.8	838 x 292 x 194	
33.1	5.90	5893	535	6808	842	0.856	46.5	13.0	221	224	175.9	838 x 292 x 176	
30.9	5.71	6234	610	7167	959	0.869	33.2	11.3	404	251	196.8	762 x 267 x 197	
30.5	5.58	5387	514	6198	807	0.864	38.1	9.39	267	220	173.0	762 x 267 x 173	
30.0	5.40	4470	411	5156	647	0.858	45.2	7.40	159	187	146.9	762 x 267 x 147	
29.7	5.30	4018	362	4644	570	0.854	49.8	6.46	119	171	133.9	762 x 267 x 134	
28.0	5.53	4916	518	5631	811	0.872	31.8	7.42	308	217	170.2	686 x 254 x 170	
27.8	5.46	4374	455	5000	710	0.871	35.5	6.42	220	194	152.4	686 x 254 x 152	
27.6	5.39	3987	409	4558	638	0.868	38.7	5.72	169	178	140.1	686 x 254 x 140	
27.2	5.24	3481	346	3994	542	0.862	43.9	4.80	116	159	125.2	686 x 254 x 125	
26.3	7.23	6589	1017	7486	1574	0.886	21.3	14.5	785	303	238.1	610 x 305 x 238	
25.9	7.07	4935	743	5547	1144	0.886	27.7	10.2	340	228	179.0	610 x 305 x 179	
25.7	7.00	4111	611	4594	937	0.886	32.7	8.17	200	190	149.2	610 x 305 x 149	
25.0	5.03	3622	391	4142	611	0.875	30.6	3.99	216	178	139.9	610 x 229 x 140	
24.9	4.97	3221	343	3676	535	0.873	34.1	3.45	154	159	125.1	610 x 229 x 125	
24.6	4.88	2874	301	3281	469	0.870	38.0	2.99	111	144	113.0	610 x 229 x 113	
24.2	4.75	2515	256	2881	400	0.864	43.1	2.52	77.0	129	101.2	610 x 229 x 101	
22.1	4.67	2793	320	3196	500	0.877	27.6	2.32	178	155	122.0	533 x 210 x 122	
21.9	4.60	2477	279	2828	436	0.875	30.9	1.99	126	139	109.0	533 x 210 x 109	
21.9	4.57	2292	256	2612	399	0.874	33.2	1.81	101	129	101.0	533 x 210 x 101	
21.7	4.51	2072	228	2360	356	0.872	36.5	1.60	75.7	117	92.1	533 x 210 x 92	
21.3	4.38	1800	192	2059	300	0.864	41.6	1.33	51.5	105	82.2	533 x 210 x 82	
19.1	4.33	1957	243	2232	379	0.881	25.7	1.18	121	125	98.3	457 x 191 x 98	
19.0	4.29	1770	218	2014	338	0.880	28.3	1.04	90.7	114	89.3	457 x 191 x 89	
18.8	4.23	1611	196	1831	304	0.877	30.9	0.922	69.2	104	82.0	457 x 191 x 82	
18.8	4.20	1458	176	1653	272	0.877	33.9	0.818	51.8	94.6	74.3	457 x 191 x 74	
18.5	4.12	1296	153	1471	237	0.872	37.9	0.705	37.1	85.5	67.1	457 x 191 x 67	

Universal beams

Dimensions and properties to BS 4: Part 1: 1993

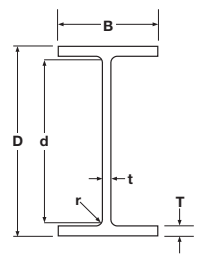

Designation		Depth of Section D mm	Width of Section B mm	Thickness of Web t mm	Thickness of Flange T mm	Root Radius r mm	Depth between fillets d mm	Ratios for Local Buckling		Second Moment of Area	
Serial Size	Mass per metre kg/m							Flange B/2T	Web d/t	Axis x-x cm ⁴	Axis y-y cm ⁴
457 x 152 x 82	82.1	465.8	155.3	10.5	18.9	10.2	407.6	4.11	38.8	36590	1185
457 x 152 x 74	74.2	462.0	154.4	9.6	17.0	10.2	407.6	4.54	42.5	32670	1047
457 x 152 x 67	67.2	458.0	153.8	9.0	15.0	10.2	407.6	5.13	45.3	28930	913
457 x 152 x 60	59.8	454.6	152.9	8.1	13.3	10.2	407.6	5.75	50.3	25500	795
457 x 152 x 52	52.3	449.8	152.4	7.6	10.9	10.2	407.6	6.99	53.6	21370	645
406 x 178 x 74	74.2	412.8	179.5	9.5	16.0	10.2	360.4	5.61	37.9	27310	1545
406 x 178 x 67	67.1	409.4	178.8	8.8	14.3	10.2	360.4	6.25	41.0	24330	1365
406 x 178 x 60	60.1	406.4	177.9	7.9	12.8	10.2	360.4	6.95	45.6	21600	1203
406 x 178 x 54	54.1	402.6	177.7	7.7	10.9	10.2	360.4	8.15	46.8	18720	1021
406 x 140 x 46	46.0	403.2	142.2	6.8	11.2	10.2	360.4	6.35	53.0	15690	538
406 x 140 x 39	39.0	398.0	141.8	6.4	8.6	10.2	360.4	8.24	56.3	12510	410
356 x 171 x 67	67.1	363.4	173.2	9.1	15.7	10.2	311.6	5.52	34.2	19460	1362
356 x 171 x 57	57.0	358.0	172.2	8.1	13.0	10.2	311.6	6.62	38.5	16040	1108
356 x 171 x 51	51.0	355.0	171.5	7.4	11.5	10.2	311.6	7.46	42.1	14140	968
356 x 171 x 45	45.0	351.4	171.1	7.0	9.7	10.2	311.6	8.82	44.5	12070	811
356 x 127 x 39	39.1	353.4	126.0	6.6	10.7	10.2	311.6	5.89	47.2	10170	358
356 x 127 x 33	33.1	349.0	125.4	6.0	8.5	10.2	311.6	7.38	51.9	8249	280
305 x 165 x 54	54.0	310.4	166.9	7.9	13.7	8.9	265.2	6.09	33.6	11700	1063
305 x 165 x 46	46.1	306.6	165.7	6.7	11.8	8.9	265.2	7.02	39.6	9899	896
305 x 165 x 40	40.3	303.4	165.0	6.0	10.2	8.9	265.2	8.09	44.2	8503	764
305 x 127 x 48	48.1	311.0	125.3	9.0	14.0	8.9	265.2	4.48	29.5	9575	461
305 x 127 x 42	41.9	307.2	124.3	8.0	12.1	8.9	265.2	5.14	33.2	8196	389
305 x 127 x 37	37.0	304.4	123.4	7.1	10.7	8.9	265.2	5.77	37.4	7171	336
305 x 102 x 33	32.8	312.7	102.4	6.6	10.8	7.6	275.9	4.74	41.8	6501	194
305 x 102 x 28	28.2	308.7	101.8	6.0	8.8	7.6	275.9	5.78	46.0	5366	155
305 x 102 x 25	24.8	305.1	101.6	5.8	7.0	7.6	275.9	7.26	47.6	4455	123
254 x 146 x 43	43.0	259.6	147.3	7.2	12.7	7.6	219.0	5.80	30.4	6544	677
254 x 146 x 37	37.0	256.0	146.4	6.3	10.9	7.6	219.0	6.72	34.8	5537	571
254 x 146 x 31	31.1	251.4	146.1	6.0	8.6	7.6	219.0	8.49	36.5	4413	448
254 x 102 x 28	28.3	260.4	102.2	6.3	10.0	7.6	225.2	5.11	35.7	4005	179
254 x 102 x 25	25.2	257.2	101.9	6.0	8.4	7.6	225.2	6.07	37.5	3415	149
254 x 102 x 22	22.0	254.0	101.6	5.7	6.8	7.6	225.2	7.47	39.5	2841	119
203 x 133 x 30	30.0	206.8	133.9	6.4	9.6	7.6	172.4	6.97	26.9	2896	385
203 x 133 x 25	25.1	203.2	133.2	5.7	7.8	7.6	172.4	8.54	30.2	2340	308
203 x 102 x 23	23.1	203.2	101.8	5.4	9.3	7.6	169.4	5.47	31.4	2105	164
178 x 102 x 19	19.0	177.8	101.2	4.8	7.9	7.6	146.8	6.41	30.6	1356	137
152 x 89 x 16	16.0	152.4	88.7	4.5	7.7	7.6	121.8	5.76	27.1	834	89.8
127 x 76 x 13	13.0	127.0	76.0	4.0	7.6	7.6	96.6	5.00	24.2	473	55.7

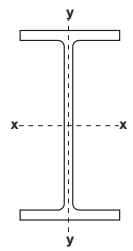

Universal beams

Dimensions and properties to BS 4: Part 1: 1993

Radius of Gyration		Elastic Modulus		Plastic Modulus		Buckling Parameter u	Torsional Index x	Warping Constant H dm ⁶	Torsional Constant J cm ⁴	Area of Section cm ²	Mass per metre kg/m	Designation
Axis x-x cm	Axis y-y cm	Axis x-x cm ³	Axis y-y cm ³	Axis x-x cm ³	Axis y-y cm ³							Serial Size
18.7	3.37	1571	153	1811	240	0.873	27.4	0.591	89.2	105	82.1	457 x 152 x 82
18.6	3.33	1414	136	1627	213	0.873	30.1	0.518	65.9	94.5	74.2	457 x 152 x 74
18.4	3.27	1263	119	1453	187	0.869	33.6	0.448	47.7	85.6	67.2	457 x 152 x 67
18.3	3.23	1122	104	1287	163	0.868	37.5	0.387	33.8	76.2	59.8	457 x 152 x 60
17.9	3.11	950	84.6	1096	133	0.859	43.9	0.311	21.4	66.6	52.3	457 x 152 x 52
17.0	4.04	1323	172	1501	267	0.882	27.6	0.608	62.8	94.5	74.2	406 x 178 x 74
16.9	3.99	1189	153	1346	237	0.880	30.5	0.533	46.1	85.5	67.1	406 x 178 x 67
16.8	3.97	1063	135	1199	209	0.880	33.8	0.466	33.3	76.5	60.1	406 x 178 x 60
16.5	3.85	930	115	1055	178	0.871	38.3	0.392	23.1	69.0	54.1	406 x 178 x 54
16.4	3.03	778	75.7	888	118	0.871	38.9	0.207	19.0	58.6	46.0	406 x 140 x 46
15.9	2.87	629	57.8	724	90.8	0.858	47.5	0.155	10.7	49.7	39.0	406 x 140 x 39
15.1	3.99	1071	157	1211	243	0.886	24.4	0.412	55.7	85.5	67.1	356 x 171 x 67
14.9	3.91	896	129	1010	199	0.882	28.8	0.330	33.4	72.6	57.0	356 x 171 x 57
14.8	3.86	796	113	896	174	0.881	32.1	0.286	23.8	64.9	51.0	356 x 171 x 51
14.5	3.76	687	94.8	775	147	0.874	36.8	0.237	15.8	57.3	45.0	356 x 171 x 45
14.3	2.68	576	56.8	659	89.1	0.871	35.2	0.105	15.1	49.8	39.1	356 x 127 x 39
14.0	2.58	473	44.7	543	70.3	0.863	42.2	0.0812	8.79	42.1	33.1	356 x 127 x 33
13.0	3.93	754	127	846	196	0.889	23.6	0.234	34.8	68.8	54.0	305 x 165 x 54
13.0	3.90	646	108	720	166	0.891	27.1	0.195	22.2	58.7	46.1	305 x 165 x 46
12.9	3.86	560	92.6	623	142	0.889	31.0	0.164	14.7	51.3	40.3	305 x 165 x 40
12.5	2.74	616	73.6	711	116	0.873	23.3	0.102	31.8	61.2	48.1	305 x 127 x 48
12.4	2.70	534	62.6	614	98.4	0.872	26.5	0.0846	21.1	53.4	41.9	305 x 127 x 42
12.3	2.67	471	54.5	539	85.4	0.872	29.7	0.0725	14.8	47.2	37.0	305 x 127 x 37
12.5	2.15	416	37.9	481	60.0	0.866	31.6	0.0442	12.2	41.8	32.8	305 x 102 x 33
12.2	2.08	348	30.5	403	48.5	0.859	37.4	0.0349	7.40	35.9	28.2	305 x 102 x 28
11.9	1.97	292	24.2	342	38.8	0.846	43.4	0.0273	4.77	31.6	24.8	305 x 102 x 25
10.9	3.52	504	92.0	566	141	0.891	21.2	0.103	23.9	54.8	43.0	254 x 146 x 43
10.8	3.48	433	78.0	483	119	0.890	24.3	0.0857	15.3	47.2	37.0	254 x 146 x 37
10.5	3.36	351	61.3	393	94.1	0.880	29.6	0.0660	8.55	39.7	31.1	254 x 146 x 31
10.5	2.22	308	34.9	353	54.8	0.874	27.5	0.0280	9.57	36.1	28.3	254 x 102 x 28
10.3	2.15	266	29.2	306	46.0	0.866	31.5	0.0230	6.42	32.0	25.2	254 x 102 x 25
10.1	2.06	224	23.5	259	37.3	0.856	36.4	0.0182	4.15	28.0	22.0	254 x 102 x 22
8.71	3.17	280	57.5	314	88.2	0.881	21.5	0.0374	10.3	38.2	30.0	203 x 133 x 30
8.56	3.10	230	46.2	258	70.9	0.877	25.6	0.0294	5.96	32.0	25.1	203 x 133 x 25
8.46	2.36	207	32.2	234	49.8	0.888	22.5	0.0154	7.02	29.4	23.1	203 x 102 x 23
7.48	2.37	153	27.0	171	41.6	0.888	22.6	0.0099	4.41	24.3	19.0	178 x 102 x 19
6.41	2.10	109	20.2	123	31.2	0.890	19.6	0.0047	3.56	20.3	16.0	152 x 89 x 16
5.35	1.84	74.6	14.7	84.2	22.6	0.895	16.3	0.0020	2.85	16.5	13.0	127 x 76 x 13

Universal columns

Dimensions and properties to BS 4: Part 1: 1993

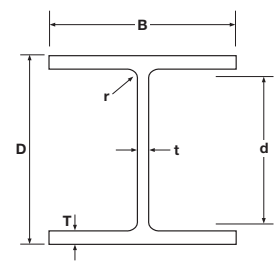

Designation Serial Size	Mass per metre kg/m	Depth of Section D mm	Width of Section B mm	Thickness of Web t mm	Thickness of Flange T mm	Root Radius r mm	Depth between fillets d mm	Ratios for Local Buckling		Second Moment of Area	
								Flange B/2T	Web d/t	Axis x-x cm ⁴	Axis y-y cm ⁴
356 x 406 x 634	633.9	474.6	424.0	47.6	77.0	15.2	290.2	2.75	6.10	274800	98130
356 x 406 x 551	551.0	455.6	418.5	42.1	67.5	15.2	290.2	3.10	6.89	226900	82670
356 x 406 x 467	467.0	436.6	412.2	35.8	58.0	15.2	290.2	3.55	8.11	183000	67830
356 x 406 x 393	393.0	419.0	407.0	30.6	49.2	15.2	290.2	4.14	9.48	146600	55370
356 x 406 x 340	339.9	406.4	403.0	26.6	42.9	15.2	290.2	4.70	10.9	122500	46850
356 x 406 x 287	287.1	393.6	399.0	22.6	36.5	15.2	290.2	5.47	12.8	99880	38680
356 x 406 x 235	235.1	381.0	394.8	18.4	30.2	15.2	290.2	6.54	15.8	79080	30990
356 x 368 x 202	201.9	374.6	374.7	16.5	27.0	15.2	290.2	6.94	17.6	66260	23690
356 x 368 x 177	177.0	368.2	372.6	14.4	23.8	15.2	290.2	7.83	20.2	57120	20530
356 x 368 x 153	152.9	362.0	370.5	12.3	20.7	15.2	290.2	8.95	23.6	48590	17550
356 x 368 x 129	129.0	355.6	368.6	10.4	17.5	15.2	290.2	10.5	27.9	40250	14610
305 x 305 x 283	282.9	365.3	322.2	26.8	44.1	15.2	246.7	3.65	9.21	78870	24630
305 x 305 x 240	240.0	352.5	318.4	23.0	37.7	15.2	246.7	4.22	10.7	64200	20310
305 x 305 x 198	198.1	339.9	314.5	19.1	31.4	15.2	246.7	5.01	12.9	50900	16300
305 x 305 x 158	158.1	327.1	311.2	15.8	25.0	15.2	246.7	6.22	15.6	38750	12570
305 x 305 x 137	136.9	320.5	309.2	13.8	21.7	15.2	246.7	7.12	17.9	32810	10700
305 x 305 x 118	117.9	314.5	307.4	12.0	18.7	15.2	246.7	8.22	20.6	27670	9059
305 x 305 x 97	96.9	307.9	305.3	9.9	15.4	15.2	246.7	9.91	24.9	22250	7308
254 x 254 x 167	167.1	289.1	265.2	19.2	31.7	12.7	200.3	4.18	10.4	30000	9870
254 x 254 x 132	132.0	276.3	261.3	15.3	25.3	12.7	200.3	5.16	13.1	22530	7531
254 x 254 x 107	107.1	266.7	258.8	12.8	20.5	12.7	200.3	6.31	15.6	17510	5928
254 x 254 x 89	88.9	260.3	256.3	10.3	17.3	12.7	200.3	7.41	19.4	14270	4857
254 x 254 x 73	73.1	254.1	254.6	8.6	14.2	12.7	200.3	8.96	23.3	11410	3908
203 x 203 x 86	86.1	222.2	209.1	12.7	20.5	10.2	160.8	5.10	12.7	9449	3127
203 x 203 x 71	71.0	215.8	206.4	10.0	17.3	10.2	160.8	5.97	16.1	7618	2537
203 x 203 x 60	60.0	209.6	205.8	9.4	14.2	10.2	160.8	7.25	17.1	6125	2065
203 x 203 x 52	52.0	206.2	204.3	7.9	12.5	10.2	160.8	8.17	20.4	5259	1778
203 x 203 x 46	46.1	203.2	203.6	7.2	11.0	10.2	160.8	9.25	22.3	4568	1548
152 x 152 x 37	37.0	161.8	154.4	8.0	11.5	7.6	123.6	6.71	15.5	2210	706
152 x 152 x 30	30.0	157.6	152.9	6.5	9.4	7.6	123.6	8.13	19.0	1748	560
152 x 152 x 23	23.0	152.4	152.2	5.8	6.8	7.6	123.6	11.2	21.3	1250	400

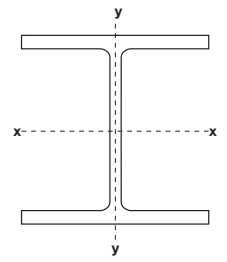

Universal columns

Dimensions and properties to BS 4: Part 1: 1993

Radius of Gyration		Elastic Modulus		Plastic Modulus		Buckling Parameter u	Torsional Index x	Warping Constant H dm ⁶	Torsional Constant J cm ⁴	Area of Section cm ²	Mass per metre kg/m	Designation	
Axis x-x cm	Axis y-y cm	Axis x-x cm ³	Axis y-y cm ³	Axis x-x cm ³	Axis y-y cm ³							Serial Size	
18.4	11.0	11580	4629	14240	7108	0.843	5.46	38.8	13720	808	633.9	356 x 406 x 634	
18.0	10.9	9962	3951	12080	6058	0.841	6.05	31.1	9240	702	551.0	356 x 406 x 551	
17.5	10.7	8383	3291	10000	5034	0.839	6.86	24.3	5809	595	467.0	356 x 406 x 467	
17.1	10.5	6998	2721	8222	4154	0.837	7.86	18.9	3545	501	393.0	356 x 406 x 393	
16.8	10.4	6031	2325	6999	3544	0.836	8.85	15.5	2343	433	339.9	356 x 406 x 340	
16.5	10.3	5075	1939	5812	2949	0.835	10.2	12.3	1441	366	287.1	356 x 406 x 287	
16.3	10.2	4151	1570	4687	2383	0.834	12.1	9.54	812	299	235.1	356 x 406 x 235	
16.1	9.60	3538	1264	3972	1920	0.844	13.4	7.16	558	257	201.9	356 x 368 x 202	
15.9	9.54	3103	1102	3455	1671	0.844	15.0	6.09	381	226	177.0	356 x 368 x 177	
15.8	9.49	2684	948	2965	1435	0.844	17.0	5.11	251	195	152.9	356 x 368 x 153	
15.6	9.43	2264	793	2479	1199	0.844	19.9	4.18	153	164	129.0	356 x 368 x 129	
14.8	8.27	4318	1529	5105	2342	0.855	7.65	6.35	2034	360	282.9	305 x 305 x 283	
14.5	8.15	3643	1276	4247	1951	0.854	8.74	5.03	1271	306	240.0	305 x 305 x 240	
14.2	8.04	2995	1037	3440	1581	0.854	10.2	3.88	734	252	198.1	305 x 305 x 198	
13.9	7.90	2369	808	2680	1230	0.851	12.5	2.87	378	201	158.1	305 x 305 x 158	
13.7	7.83	2048	692	2297	1053	0.851	14.2	2.39	249	174	136.9	305 x 305 x 137	
13.6	7.77	1760	589	1958	895	0.850	16.2	1.98	161	150	117.9	305 x 305 x 118	
13.4	7.69	1445	479	1592	726	0.850	19.3	1.56	91.2	123	96.9	305 x 305 x 97	
11.9	6.81	2075	744	2424	1137	0.851	8.49	1.63	626	213	167.1	254 x 254 x 167	
11.6	6.69	1631	576	1869	878	0.850	10.3	1.19	319	168	132.0	254 x 254 x 132	
11.3	6.59	1313	458	1484	697	0.848	12.4	0.898	172	136	107.1	254 x 254 x 107	
11.2	6.55	1096	379	1224	575	0.850	14.5	0.717	102	113	88.9	254 x 254 x 89	
11.1	6.48	898	307	992	465	0.849	17.3	0.562	57.6	93.1	73.1	254 x 254 x 73	
9.28	5.34	850	299	977	456	0.850	10.2	0.318	137	110	86.1	203 x 203 x 86	
9.18	5.30	706	246	799	374	0.853	11.9	0.250	80.2	90.4	71.0	203 x 203 x 71	
8.96	5.20	584	201	656	305	0.846	14.1	0.197	47.2	76.4	60.0	203 x 203 x 60	
8.91	5.18	510	174	567	264	0.848	15.8	0.167	31.8	66.3	52.0	203 x 203 x 52	
8.82	5.13	450	152	497	231	0.847	17.7	0.143	22.2	58.7	46.1	203 x 203 x 46	
6.85	3.87	273	91.5	309	140	0.848	13.3	0.0399	19.2	47.1	37.0	152 x 152 x 37	
6.76	3.83	222	73.3	248	112	0.849	16.0	0.0308	10.5	38.3	30.0	152 x 152 x 30	
6.54	3.70	164	52.6	182	80.2	0.840	20.7	0.0212	4.63	29.2	23.0	152 x 152 x 23	

Universal bearing piles

Dimensions and properties to BS 4: Part 1: 1993

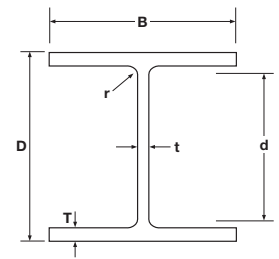

Designation		Depth of Section D mm	Width of Section B mm	Thickness of Web t mm	Thickness of Flange T mm	Root Radius r mm	Depth between fillets d mm	Ratios for Local Buckling		Second Moment of Area	
Serial Size	Mass per metre kg/m							Flange B/2T	Web d/t	Axis x-x cm ⁴	Axis y-y cm ⁴
356 x 368 x 174	173.9	361.4	378.5	20.3	20.4	15.2	290.2	9.28	14.3	51010	18460
356 x 368 x 152	152.0	356.4	376.0	17.8	17.9	15.2	290.2	10.5	16.3	43970	15880
356 x 368 x 133	133.0	352.0	373.8	15.6	15.7	15.2	290.2	11.9	18.6	37980	13680
356 x 368 x 109	108.9	346.4	371.0	12.8	12.9	15.2	290.2	14.4	22.7	30630	10990
305 x 305 x 223	222.9	337.9	325.7	30.3	30.4	15.2	246.7	5.36	8.14	52700	17580
305 x 305 x 186	186.0	328.3	320.9	25.5	25.6	15.2	246.7	6.27	9.67	42610	14140
305 x 305 x 149	149.1	318.5	316.0	20.6	20.7	15.2	246.7	7.63	12.0	33070	10910
305 x 305 x 126	126.1	312.3	312.9	17.5	17.6	15.2	246.7	8.89	14.1	27410	9002
305 x 305 x 110	110.0	307.9	310.7	15.3	15.4	15.2	246.7	10.1	16.1	23560	7709
305 x 305 x 95	94.9	303.7	308.7	13.3	13.3	15.2	246.7	11.6	18.5	20040	6529
305 x 305 x 88	88.0	301.7	307.8	12.4	12.3	15.2	246.7	12.5	19.9	18420	5984
305 x 305 x 79	78.9	299.3	306.4	11.0	11.1	15.2	246.7	13.8	22.4	16440	5326
254 x 254 x 85	85.1	254.3	260.4	14.4	14.3	12.7	200.3	9.10	13.9	12280	4215
254 x 254 x 71	71.0	249.7	258.0	12.0	12.0	12.7	200.3	10.8	16.7	10070	3439
254 x 254 x 63	63.0	247.1	256.6	10.6	10.7	12.7	200.3	12.0	18.9	8860	3016
203 x 203 x 54	53.9	204.0	207.7	11.3	11.4	10.2	160.8	9.11	14.2	5027	1705
203 x 203 x 45	44.9	200.2	205.9	9.5	9.5	10.2	160.8	10.8	16.9	4100	1384

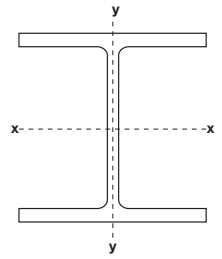

Universal bearing piles

Dimensions and properties to BS 4: Part 1: 1993

Radius of Gyration		Elastic Modulus		Plastic Modulus		Buckling Parameter u	Torsional Index x	Warping Constant H dm ⁶	Torsional Constant J cm ⁴	Area of Section cm ²	Mass per metre kg/m	Designation
Axis x-x cm	Axis y-y cm	Axis x-x cm ³	Axis y-y cm ³	Axis x-x cm ³	Axis y-y cm ³							Serial Size
15.2	9.13	2823	976	3186	1497	0.821	15.8	5.37	330	221	173.9	356 x 368 x 174
15.1	9.05	2468	845	2767	1293	0.821	17.8	4.55	223	194	152.0	356 x 368 x 152
15.0	8.99	2158	732	2406	1118	0.822	20.1	3.87	151	169	133.0	356 x 368 x 133
14.9	8.90	1769	592	1956	903	0.823	24.2	3.05	84.6	139	108.9	356 x 368 x 109
13.6	7.87	3119	1079	3653	1680	0.826	9.55	4.15	943	284	222.9	305 x 305 x 223
13.4	7.73	2596	881	3003	1366	0.827	11.1	3.24	560	237	186.0	305 x 305 x 186
13.2	7.58	2076	691	2370	1065	0.828	13.5	2.42	295	190	149.1	305 x 305 x 149
13.1	7.49	1755	575	1986	885	0.829	15.7	1.95	182	161	126.1	305 x 305 x 126
13.0	7.42	1531	496	1720	762	0.830	17.7	1.65	122	140	110.0	305 x 305 x 110
12.9	7.35	1320	423	1475	648	0.830	20.2	1.38	80.0	121	94.9	305 x 305 x 95
12.8	7.31	1221	389	1361	595	0.830	21.6	1.25	64.2	112	88.0	305 x 305 x 88
12.8	7.28	1099	348	1218	531	0.832	23.9	1.11	46.9	100	78.9	305 x 305 x 79
10.6	6.24	966	324	1092	498	0.825	15.6	0.607	81.8	108	85.1	254 x 254 x 85
10.6	6.17	807	267	904	409	0.826	18.4	0.486	48.4	90.4	71.0	254 x 254 x 71
10.5	6.13	717	235	799	360	0.827	20.5	0.421	34.3	80.2	63.0	254 x 254 x 63
8.55	4.98	493	164	557	252	0.827	15.8	0.158	32.7	68.7	53.9	203 x 203 x 54
8.46	4.92	410	134	459	206	0.827	18.6	0.126	19.2	57.2	44.9	203 x 203 x 45

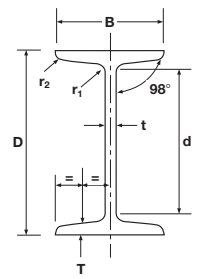

Joists

Dimensions and properties to BS 4: Part 1: 1993

Inside slope 8°

Designation		Depth of Section D mm	Width of Section B mm	Thickness of Web t mm	Thickness of Flange T mm	Radius		Depth between fillets d mm	Ratios for Local Buckling		Second Moment of Area	
Serial Size	Mass per metre kg/m					Root r ₁ mm	Toe r ₂ mm		Flange B/T	Web d/t	Axis x-x cm ⁴	Axis y-y cm ⁴
203 x 152 x 52	52.3	203.2	152.4	8.9	16.5	15.5	7.6	133.2	4.62	15.0	4800	816
152 x 127 x 37	37.3	152.4	127	10.4	13.2	13.5	6.6	94.3	4.81	9.07	1820	378

All joists subject to viable mount size. For details of the 'C' and 'S' joists, see page 42/43.

Parallel flange channels

Dimensions and properties to BS 4: Part 1: 1993

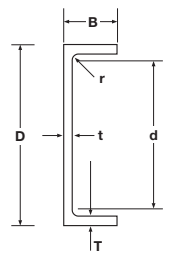

Designation		Depth of Section D mm	Width of Section B mm	Thickness of Web t mm	Thickness of Flange T mm	Distance of Cy cm	Root Radius r mm	Depth between fillets d mm	Ratios for Local Buckling		Second Moment of Area	
Serial Size	Mass per metre kg/m								Flange B/T	Web d/t	Axis x-x cm ⁴	Axis y-y cm ⁴
430 x 100 x 64	64.40	430	100	11.00	19.00	2.62	15	362.0	5.26	32.9	21940	722
380 x 100 x 54	54.00	380	100	9.50	17.50	2.79	15	315.0	5.71	33.2	15030	643
300 x 100 x 46	45.50	300	100	9.00	16.50	3.05	15	237.0	6.06	26.3	8229	568
300 x 90 x 41	41.40	300	90	9.00	15.50	2.60	12	245.0	5.81	27.2	7218	404
260 x 90 x 35	34.80	260	90	8.00	14.00	2.74	12	208.0	6.43	26.0	4728	353
260 x 75 x 28	27.60	260	75	7.00	12.00	2.10	12	212.0	6.25	30.3	3619	185
230 x 90 x 32	32.20	230	90	7.50	14.00	2.92	12	178.0	6.43	23.7	3518	334
230 x 75 x 26	25.70	230	75	6.50	12.50	2.30	12	181.0	6.00	27.8	2748	181
200 x 90 x 30	29.70	200	90	7.00	14.00	3.12	12	148.0	6.43	21.1	2523	314
200 x 75 x 23	23.40	200	75	6.00	12.50	2.48	12	151.0	6.00	25.2	1963	170
180 x 90 x 26	26.10	180	90	6.50	12.50	3.17	12	131.0	7.20	20.2	1817	277
180 x 75 x 20	20.30	180	75	6.00	10.50	2.41	12	135.0	7.14	22.5	1370	146
150 x 90 x 24	23.90	150	90	6.50	12.00	3.30	12	102.0	7.50	15.7	1162	253
150 x 75 x 18	17.90	150	75	5.50	10.00	2.58	12	106.0	7.50	19.3	861	131
125 x 65 x 15	14.80	125	65	5.50	9.50	2.25	12	82.0	6.84	14.9	483	80.0
100 x 50 x 10	10.20	100	50	5.00	8.50	1.73	9	65.0	5.88	13.0	208	32.3

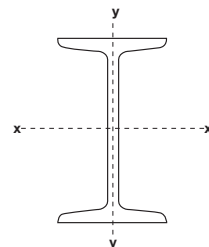

Joists

Dimensions and properties to BS 4: Part 1: 1993

Radius of Gyration		Elastic Modulus		Plastic Modulus		Buckling Parameter u	Torsional Index x	Warping Constant H dm ⁶	Torsional Constant J cm ⁴	Area of Section cm ²	Mass per metre kg/m	Designation
Axis x-x cm	Axis y-y cm	Axis x-x cm ³	Axis y-y cm ³	Axis x-x cm ³	Axis y-y cm ³							Serial Size
10.7	4.67	947	224	1080	371	0.888	11	0.312	152	105	82	254 x 203 x 82
8.49	3.5	472	107	541	176	0.890	10.7	0.0711	64.8	66.6	52.3	203 x 152 x 52
6.19	2.82	239	59.6	279	99.8	0.867	9.33	0.0183	33.9	47.5	37.3	152 x 127 x 37
5.12	2.54	154	42.3	181	70.8	0.853	8.77	0.00807	20.8	37.4	29.3	127 x 114 x 29
5.26	2.63	149	41.3	172	68.2	0.868	9.31	0.00788	16.9	34.2	26.9	127 x 114 x 27
4.07	2.29	95.6	30.3	113	50.6	0.836	7.42	0.00321	14.2	29.3	23	102 x 102 x 23
4.01	0.907	30.1	3.51	35.4	6.03	0.872	14.9	0.000178	1.25	9.5	7.5	102 x 44 x 7
3.51	2.02	69	22.8	82.7	38	0.830	6.58	0.00158	11.5	24.9	19.5	89 x 89 x 19
3.12	1.79	41.5	13.6	48.7	22.4	0.853	7.21	0.000595	4.59	16.2	12.8	76 x 76 x 13

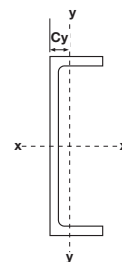

Parallel flange channels

Dimensions and properties to BS 4: Part 1: 1993

Radius of Gyration		Elastic Modulus		Plastic Modulus		Buckling Parameter u	Torsional Index x	Warping Constant H dm ⁶	Torsional Constant J cm ⁴	Area of Section cm ²	Mass per metre kg/m	Designation
Axis x-x cm	Axis y-y cm	Axis x-x cm ³	Axis y-y cm ³	Axis x-x cm ³	Axis y-y cm ³							Serial Size
16.3	2.97	1020	97.9	1222	176	0.917	22.5	0.219	63.0	82.1	64.4	430 x 100 x 64
14.8	3.06	791	89.2	933	161	0.932	21.2	0.150	45.7	68.7	54	380 x 100 x 54
11.9	3.13	549	81.7	641	148	0.944	17.0	0.0813	36.8	58.0	45.5	300 x 100 x 46
11.7	2.77	481	63.1	568	114	0.934	18.4	0.0581	28.8	52.7	41.4	300 x 90 x 41
10.3	2.82	364	56.3	425	102	0.942	17.2	0.0379	20.6	44.4	34.8	260 x 90 x 35
10.1	2.30	278	34.4	328	62.0	0.932	20.5	0.0203	11.7	35.1	27.6	260 x 75 x 28
9.27	2.86	306	55.0	355	98.9	0.950	15.1	0.0279	19.3	41.0	32.2	230 x 90 x 32
9.17	2.35	239	34.8	278	63.2	0.947	17.3	0.0153	11.8	32.7	25.7	230 x 75 x 26
8.16	2.88	252	53.4	291	94.5	0.954	12.9	0.0197	18.3	37.9	29.7	200 x 90 x 30
8.11	2.39	196	33.8	227	60.6	0.956	14.8	0.0107	11.1	29.9	23.4	200 x 75 x 23
7.40	2.89	202	47.4	232	83.5	0.949	12.8	0.0141	13.3	33.2	26.1	180 x 90 x 26
7.27	2.38	152	28.8	176	51.8	0.946	15.3	0.0075	7.34	25.9	20.3	180 x 75 x 20
6.18	2.89	155	44.4	179	76.9	0.936	10.8	0.0089	11.8	30.4	23.9	150 x 90 x 24
6.15	2.40	115	26.6	132	47.2	0.946	13.1	0.0047	6.10	22.8	17.9	150 x 75 x 18
5.07	2.06	77.3	18.8	89.9	33.2	0.942	11.1	0.0019	4.72	18.8	14.8	125 x 65 x 15
4.00	1.58	41.5	9.89	48.9	17.5	0.942	10.0	0.0005	2.53	13.0	10.2	100 x 50 x 10

Equal angles

Dimensions and properties to BS EN 10056-1: 1999

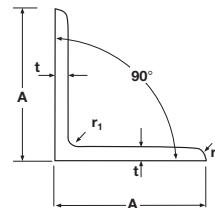

Designation	Serial Size A x A x t mm x mm x mm	Mass per metre kg/m	Root Radius r_1 mm	Toe Radius r_2 mm	Area of Section cm ²	Distance of centre of gravity C cm	Second Moment of Area		
							Axis x-x, y-y cm ⁴	Axis u-u cm ⁴	Axis v-v cm ⁴
	200 x 200 x 24	71.1	18	9.0	90.6	5.84	3331	5280	1380
	200 x 200 x 20	59.9	18	9.0	76.3	5.68	2851	4530	1170
	200 x 200 x 18	54.2	18	9.0	69.1	5.60	2600	4150	1050
	200 x 200 x 16	48.5	18	9.0	61.8	5.52	2342	3720	960
†	150 x 150 x 18	40.1	16	8.0	51.0	4.37	1050	1680	440
	150 x 150 x 15	33.8	16	8.0	43.0	4.25	898	1430	370
	150 x 150 x 12	27.3	16	8.0	34.8	4.12	737	1170	303
	150 x 150 x 10	23.0	16	8.0	29.3	4.03	624	990	258
†	120 x 120 x 15	26.6	13	6.5	33.9	3.51	445	710	186
	120 x 120 x 12	21.6	13	6.5	27.5	3.40	368	584	152
	120 x 120 x 10	18.2	13	6.5	23.2	3.31	313	497	129
†	120 x 120 x 8	14.7	13	6.5	18.7	3.23	256	411	107
†	100 x 100 x 15	21.9	12	6.0	27.9	3.02	249	395	105
	100 x 100 x 12	17.8	12	6.0	22.7	2.90	207	328	85.7
	100 x 100 x 10	15.0	12	6.0	19.2	2.82	177	280	73
	100 x 100 x 8	12.2	12	6.0	15.5	2.74	145	230	59.9
†	90 x 90 x 12	15.9	11	5.5	20.3	2.66	148	235	62
	90 x 90 x 10	13.4	11	5.5	17.1	2.58	127	201	52.6
	90 x 90 x 8	10.9	11	5.5	13.9	2.50	104	166	43.1
	90 x 90 x 7	9.6	11	5.5	12.2	2.45	92.6	147	38.3

† These sizes are in addition to our standard range to BS EN 10056-1: 1999 specification

Equal angles

Dimensions and properties to BS EN 10056-1: 1999

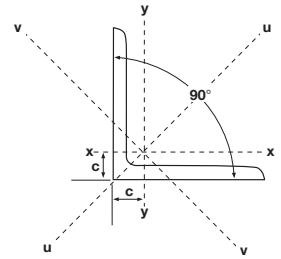

Radius of Gyration			Elastic Modulus	Torsional Constant	Equivalent Slenderness Coefficient	Mass per metre	Designation
Axis x-x, y-y cm	Axis u-u cm	Axis v-v cm					
6.06	7.64	3.90	235	182	2.50	71.1	200 x 200 x 24
6.11	7.70	3.92	199	107	3.05	59.9	200 x 200 x 20
6.13	7.75	3.90	181	78.9	3.43	54.2	200 x 200 x 18
6.16	7.76	3.94	162	56.1	3.85	48.5	200 x 200 x 16
4.54	5.73	2.92	98.8	58.6	2.48	40.1	150 x 150 x 18 †
4.57	5.76	2.93	83.5	34.6	3.01	33.8	150 x 150 x 15
4.60	5.80	2.95	67.8	18.2	3.77	27.3	150 x 150 x 12
4.62	5.82	2.97	56.9	10.8	4.51	23.0	150 x 150 x 10
3.62	4.57	2.34	52.4	27.0	2.37	26.6	120 x 120 x 15 †
3.65	4.60	2.35	42.7	14.2	2.99	21.6	120 x 120 x 12
3.67	4.63	2.36	36.0	8.41	3.61	18.2	120 x 120 x 10
3.69	4.67	2.38	29.1	4.44	4.56	14.7	120 x 120 x 8 †
2.98	3.76	1.94	35.6	22.3	1.92	21.9	100 x 100 x 15 †
3.02	3.80	1.94	29.1	11.8	2.44	17.8	100 x 100 x 12
3.04	3.83	1.95	24.6	6.97	2.94	15.0	100 x 100 x 10
3.06	3.85	1.96	20.0	3.68	3.70	12.2	100 x 100 x 8
2.70	3.40	1.75	23.4	10.46	2.17	15.9	90 x 90 x 12 †
2.72	3.42	1.75	19.8	6.20	2.64	13.4	90 x 90 x 10
2.74	3.45	1.76	16.1	3.28	3.33	10.9	90 x 90 x 8
2.75	3.46	1.77	14.1	2.24	3.80	9.6	90 x 90 x 7

Unequal angles

Dimensions and properties to BS EN 10056-1: 1999

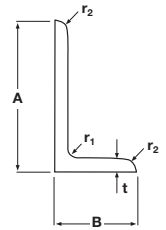

	Designation Serial Size A x B x t mm x mm x mm	Mass per metre kg/m	Root Radius r ₁ mm	Toe Radius r ₂ mm	Area of Section cm ²	Distance of centre of gravity		Second Moment of Area			
						C _x cm	C _y cm	Axis x-x	Axis y-y	Axis u-u	Axis v-v
								cm ⁴	cm ⁴	cm ⁴	cm ⁴
†	200 x 150 x 18	47.1	15	7.5	60.0	6.33	3.85	2376	1146	2920	623
	200 x 150 x 15	39.6	15	7.5	50.5	6.21	3.73	2023	979	2480	526
	200 x 150 x 12	32.0	15	7.5	40.8	6.08	3.61	1653	803	2030	430
	200 x 100 x 15	33.7	15	7.5	43.0	7.16	2.22	1759	299	1860	193
	200 x 100 x 12	27.3	15	7.5	34.8	7.03	2.10	1441	247	1530	159
	200 x 100 x 10	23.0	15	7.5	29.2	6.93	2.01	1219	210	1290	135
	150 x 90 x 15	26.6	12	6.0	33.9	5.21	2.23	761	205	841	126
	150 x 90 x 12	21.6	12	6.0	27.5	5.08	2.12	627	171	694	104
	150 x 90 x 10	18.2	12	6.0	23.2	5.00	2.04	533	146	591	88.3
	150 x 75 x 15	24.8	12	6.0	31.7	5.52	1.81	713	119	753	78.6
	150 x 75 x 12	20.2	12	6.0	25.7	5.40	1.69	589	99.6	623	64.7
	150 x 75 x 10	17.0	12	6.0	21.7	5.31	1.61	501	85.4	531	55.1
	125 x 75 x 12	17.8	11	5.5	22.7	4.31	1.84	354	95.5	391	58.5
	125 x 75 x 10	15.0	11	5.5	19.1	4.23	1.76	302	82.1	334	49.9
	125 x 75 x 8	12.2	11	5.5	15.5	4.14	1.68	247	67.6	274	40.9
	100 x 75 x 12	15.4	10	5.0	19.7	3.27	2.03	189	90.2	230	49.5
	100 x 75 x 10	13.0	10	5.0	16.6	3.19	1.95	162	77.6	197	42.2
	100 x 75 x 8	10.6	10	5.0	13.5	3.10	1.87	133	64.1	162	34.6
†	100 x 65 x 10	12.3	10	5.0	15.6	3.36	1.63	154	51.0	175	30.1
†	100 x 65 x 8	9.9	10	5.0	12.7	3.27	1.55	127	42.2	144	24.8
†	100 x 65 x 7	8.8	10	5.0	11.2	3.23	1.51	113	37.6	128	22

† These sizes are in addition to our standard range to BS EN 10056-1: 1999 specification

Unequal angles

Dimensions and properties to BS EN 10056-1: 1999

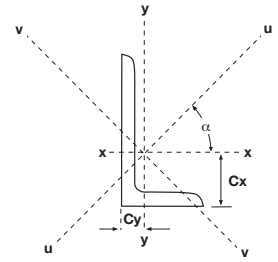

Radius of Gyration				Elastic Modulus		Angle Axis x-x to Axis y-y Tan α	Torsional Constant J cm ⁴	Equivalent Slenderness Coefficient		Mono- Symmetry Index Ψ_a	Mass per metre kg/m	Designation	
Axis x-x cm	Axis y-y cm	Axis u-u cm	Axis v-v cm	Axis x-x cm ²	Axis y-y cm ²			Min. Φ_a	Max. Φ_a			Mass per metre kg/m	Serial Size A x B x t mm x mm x mm
6.29	4.37	6.97	3.22	174	103	0.549	67.9	2.93	3.72	4.60	47.1	200 x 150 x 18	†
6.33	4.40	7.00	3.23	147	86.9	0.551	39.9	3.53	4.50	5.55	39.6	200 x 150 x 15	
6.36	4.44	7.04	3.25	119	70.5	0.552	20.9	4.43	5.70	6.97	32.0	200 x 150 x 12	
6.40	2.64	6.59	2.12	137	38.4	0.260	34.3	3.54	5.17	9.19	33.7	200 x 100 x 15	
6.43	2.67	6.63	2.14	111	31.3	0.262	18.0	4.42	6.57	11.5	27.3	200 x 100 x 12	
6.46	2.68	6.65	2.15	93.3	26.3	0.263	10.66	5.26	7.92	13.9	23.0	200 x 100 x 10	
4.74	2.46	4.98	1.93	77.7	30.4	0.354	26.8	2.58	3.59	5.96	26.6	150 x 90 x 15	
4.78	2.49	5.02	1.94	63.3	24.8	0.358	14.1	3.24	4.58	7.50	21.6	150 x 90 x 12	
4.80	2.51	5.05	1.95	53.3	21.0	0.360	8.30	3.89	5.56	9.03	18.2	150 x 90 x 10	
4.75	1.94	4.88	1.58	75.2	21.0	0.253	25.1	2.62	3.74	6.84	24.8	150 x 75 x 15	
4.78	1.97	4.92	1.59	61.3	17.1	0.258	13.2	3.30	4.79	8.60	20.2	150 x 75 x 12	
4.81	1.99	4.95	1.60	51.7	14.5	0.261	7.8	3.95	5.83	10.4	17.0	150 x 75 x 10	
3.95	2.05	4.15	1.61	43.2	16.9	0.354	11.6	2.66	3.73	6.23	17.8	125 x 75 x 12	
3.97	2.07	4.18	1.61	36.5	14.3	0.357	6.87	3.21	4.55	7.50	15.0	125 x 75 x 10	
4.00	2.09	4.21	1.63	29.6	11.6	0.360	3.62	4.00	5.75	9.43	12.2	125 x 75 x 8	
3.10	2.14	3.42	1.59	28.1	16.5	0.540	10.05	2.10	2.64	3.46	15.4	100 x 75 x 12	
3.12	2.16	3.45	1.59	23.8	14.0	0.544	5.95	2.54	3.22	4.17	13.0	100 x 75 x 10	
3.14	2.18	3.47	1.60	19.3	11.4	0.547	3.13	3.18	4.08	5.24	10.6	100 x 75 x 8	
3.14	1.81	3.35	1.39	23.2	10.5	0.410	5.61	2.52	3.43	5.45	12.3	100 x 65 x 10	†
3.16	1.83	3.37	1.40	18.9	8.54	0.413	2.96	3.14	4.35	6.86	9.9	100 x 65 x 8	†
3.17	1.83	3.39	1.40	16.6	7.53	0.415	2.02	3.58	5.00	7.85	8.8	100 x 65 x 7	†

ASB (asymmetric beams) Slimdek® beam

Dimensions and properties

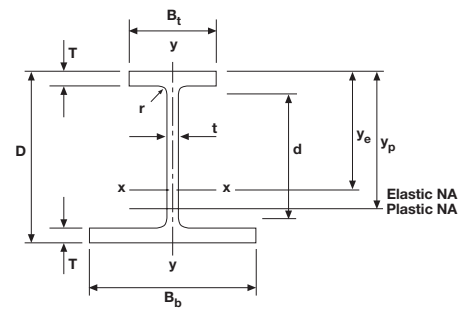

Designation Serial Size	Mass per metre kg/m	Depth of Section D mm	Width of Top Flange B_t mm	Width of Bottom Flange B_b mm	Thickness of Web t mm	Thickness of Flange T mm	Root Radius r mm	Depth between fillets d mm	Ratios for Local Buckling			Elastic Neutral Axis Position y_e cm	Second Moment of Area	
									Top Flange $B_t/2T$	Bottom Flange $B_b/2T$	Web d/t		Axis x-x cm ⁴	Axis y-y cm ⁴
300 ASB(FE) 249	249.2	342	203	313	40	40	27	208	2.54	3.91	5.20	19.2	52920	13190
300 ASB 196	195.5	342	183	293	20	40	27	208	2.29	3.66	10.4	19.8	45870	10460
300 ASB(FE) 185	184.6	320	195	305	32	29	27	208	3.36	5.26	6.50	18.0	35660	8752
300 ASB 155	155.4	326	179	289	16	32	27	208	2.80	4.52	13.0	18.9	34510	7989
300 ASB(FE) 153	152.8	310	190	300	27	24	27	208	3.96	6.25	7.70	17.4	28400	6840
280 ASB(FE) 136	136.4	288	190	300	25	22	24	196	4.32	6.82	7.84	16.3	22220	6256
280 ASB 124	123.9	296	178	288	13	26	24	196	3.42	5.54	15.1	17.2	23450	6410
280 ASB 105	104.7	288	176	286	11	22	24	196	4.00	6.50	17.8	16.8	19250	5298
280 ASB(FE) 100	100.3	276	184	294	19	16	24	196	5.75	9.19	10.3	15.6	15510	4245
280 ASB 74	73.6	272	175	285	10	14	24	196	6.25	10.2	19.6	15.7	12190	3334

For further information see 'Slimdek® - Engineered flooring solution brochure or refer to the contact details on page 42. Free design software is available.

ASB (asymmetric beams)

Slimdek® beam

Dimensions and properties

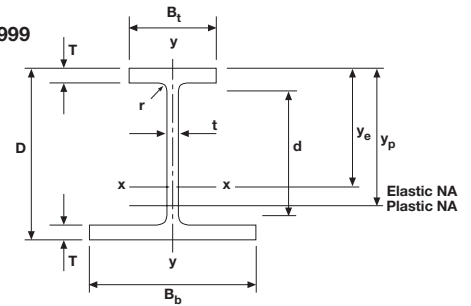

Elastic Modulus			Radius of Gyration		Plastic Neutral Axis Position y_p cm	Plastic Modulus		Buckling Parameter u	Torsional Index x	Warping Constant H dm^6	Torsional Constant J cm^4	Area of Section cm^2	Mass per metre kg/m	Designation	
Axis x-x top cm^3	Axis x-x bottom cm^3	Axis y-y cm^3	Axis x-x cm	Axis y-y cm		Axis x-x cm^3	Axis y-y cm^3							Serial Size	
2757	3528	843	12.9	6.45	22.6	3761	1512	0.825	6.80	2.00	2004	317	249.2	300 ASB(FE) 249	
2321	3185	714	13.6	6.48	28.1	3055	1229	0.845	7.86	1.50	1177	249	195.5	300 ASB 196	
1984	2547	574	12.3	6.10	21.0	2658	1030	0.822	8.56	1.20	871	235	184.6	300 ASB(FE) 185	
1825	2519	553	13.2	6.35	27.3	2361	949	0.843	9.40	1.07	620	198	155.4	300 ASB 155	
1628	2088	456	12.1	5.93	20.4	2160	816	0.822	9.97	0.895	513	195	152.8	300 ASB(FE) 153	
1367	1778	417	11.3	6.00	19.2	1806	740	0.814	10.2	0.710	379	174	136.4	280 ASB(FE) 136	
1360	1891	445	12.2	6.37	25.8	1730	761	0.832	10.5	0.721	332	158	123.9	280 ASB 124	
1145	1604	370	12.0	6.30	25.4	1441	632	0.831	12.1	0.574	207	133	104.7	280 ASB 105	
995	1293	289	11.0	5.76	18.4	1295	510	0.815	13.1	0.451	160	128	100.3	280 ASB(FE) 100	
776	1060	234	11.4	5.96	21.3	979	402	0.830	16.6	0.338	72.2	93.7	73.6	280 ASB 74	

Structural tees split from universal beams

Dimensions and Properties to BS4: Part 1: 1993

Properties have been calculated assuming that there is no loss of material due to splitting.

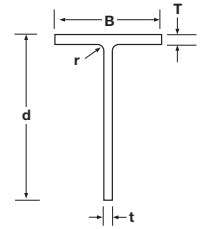

Designation Serial Size	Mass per metre kg/m	Cut from Universal Beam	Width of Section B mm	Depth of Section d mm	Thickness of Web t mm	Thickness of Flange T mm	Root Radius r mm	Ratios for Local Buckling		Dimension C _x cm	Second Moment of Area	
								Flange B/2T	Web d/t		Axis x-x cm ⁴	Axis y-y cm ⁴
254 x 343 x 63	62.6	686 x 254 x 125	253.00	338.90	11.70	16.20	15.20	7.81	29.0	8.85	8980	2190
305 x 305 x 90	89.5	610 x 305 x 179	307.10	310.00	14.10	23.60	16.50	6.51	22.0	6.69	9040	5700
305 x 305 x 75	74.6	610 x 305 x 149	304.80	306.10	11.80	19.70	16.50	7.74	25.9	6.45	7410	4650
229 x 305 x 70	69.9	610 x 229 x 140	230.20	308.50	13.10	22.10	12.70	5.21	23.5	7.61	7740	2250
229 x 305 x 63	62.5	610 x 229 x 125	229.00	306.00	11.90	19.60	12.70	5.84	25.7	7.54	6900	1970
229 x 305 x 57	56.5	610 x 229 x 113	228.20	303.70	11.10	17.30	12.70	6.60	27.4	7.58	6270	1720
229 x 305 x 51	50.6	610 x 229 x 101	227.60	301.20	10.50	14.80	12.70	7.69	28.7	7.78	5690	1460
210 x 267 x 61	61.0	533 x 210 x 122	211.90	272.20	12.70	21.30	12.70	4.97	21.4	6.66	5160	1690
210 x 267 x 55	54.5	533 x 210 x 109	210.80	269.70	11.60	18.80	12.70	5.61	23.3	6.61	4600	1470
210 x 267 x 51	50.5	533 x 210 x 101	210.00	268.30	10.80	17.40	12.70	6.03	24.8	6.53	4250	1350
210 x 267 x 46	46.0	533 x 210 x 92	209.30	266.50	10.10	15.60	12.70	6.71	26.4	6.55	3880	1190
210 x 267 x 41	41.1	533 x 210 x 82	208.80	264.10	9.60	13.20	12.70	7.91	27.5	6.75	3530	1000
191 x 229 x 49	49.1	457 x 191 x 98	192.80	233.50	11.40	19.60	10.20	4.92	20.5	5.53	2970	1170
191 x 229 x 45	44.6	457 x 191 x 89	191.90	231.60	10.50	17.70	10.20	5.42	22.1	5.47	2680	1040
191 x 229 x 41	41.0	457 x 191 x 82	191.30	229.90	9.90	16.00	10.20	5.98	23.2	5.47	2470	935
191 x 229 x 37	37.1	457 x 191 x 74	190.40	228.40	9.00	14.50	10.20	6.57	25.4	5.38	2220	836
191 x 229 x 34	33.5	457 x 191 x 67	189.90	226.60	8.50	12.70	10.20	7.48	26.7	5.46	2030	726
152 x 229 x 41	41.0	457 x 152 x 82	155.30	232.80	10.50	18.90	10.20	4.11	22.2	5.96	2600	592
152 x 229 x 37	37.1	457 x 152 x 74	154.40	230.90	9.60	17.00	10.20	4.54	24.1	5.88	2330	523
152 x 229 x 34	33.6	457 x 152 x 67	153.80	228.90	9.00	15.00	10.20	5.13	25.4	5.91	2120	456
152 x 229 x 30	29.9	457 x 152 x 60	152.90	227.20	8.10	13.30	10.20	5.75	28.0	5.84	1880	397
152 x 229 x 26	26.1	457 x 152 x 52	152.40	224.80	7.60	10.90	10.20	6.99	29.6	6.04	1670	322

Structural tees split from universal beams

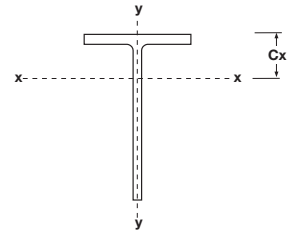

Dimensions and Properties to BS4: Part 1: 1993

Properties have been calculated assuming that there is no loss of material due to splitting.

Radius of Gyration		Elastic Modulus			Plastic Modulus		Buckling Parameter u	Torsional Index x	Mono-symmetry Index Ψ	Warping Constant (*) H cm ⁶	Torsional Constant J cm ⁴	Area of Section cm ²	Designation	
Axis x-x cm	Axis y-y cm	Axis Flange x-x cm ³	Axis Toe x-x cm ³	Axis y-y cm ³	Axis x-x cm ³	Axis y-y cm ³							Mass per metre kg/m	Serial Size
10.6	5.24	1010	358	173	643	271	0.651	22.0	0.740	2090	57.9	79.7	62.6	254 x 343 x 63
8.91	7.07	1350	372	371	656	572	0.484	13.8	0.664	4710	170	114	89.5	305 x 305 x 90
8.83	7.00	1150	307	305	538	469	0.483	16.4	0.666	2690	99.8	95.0	74.6	305 x 305 x 75
9.32	5.03	1020	333	196	592	306	0.613	15.3	0.727	2560	108	89.1	69.9	229 x 305 x 70
9.31	4.97	915	299	172	531	268	0.617	17.1	0.728	1840	76.9	79.7	62.5	229 x 305 x 63
9.33	4.88	826	275	150	489	235	0.626	19.0	0.731	1400	55.5	72.0	56.5	229 x 305 x 57
9.40	4.76	732	255	128	456	200	0.644	21.6	0.736	1080	38.3	64.4	50.6	229 x 305 x 51
8.15	4.67	775	251	160	446	250	0.600	13.8	0.719	1660	88.9	77.7	61.0	210 x 267 x 61
8.14	4.60	697	226	140	401	218	0.605	15.5	0.721	1200	63.0	69.4	54.5	210 x 267 x 55
8.12	4.57	650	209	128	371	200	0.606	16.6	0.722	951	50.3	64.3	50.5	210 x 267 x 51
8.14	4.51	593	193	114	343	178	0.613	18.3	0.724	737	37.7	58.7	46.0	210 x 267 x 46
8.21	4.38	523	179	96.1	320	150	0.634	20.8	0.730	565	25.7	52.3	41.1	210 x 267 x 41
6.88	4.33	536	167	122	296	189	0.573	12.9	0.705	835	60.5	62.6	49.1	191 x 229 x 49
6.87	4.29	491	152	109	269	169	0.576	14.1	0.706	628	45.2	56.9	44.6	191 x 229 x 45
6.88	4.23	452	141	97.8	250	152	0.583	15.5	0.708	494	34.5	52.2	41.0	191 x 229 x 41
6.86	4.20	413	127	87.8	225	136	0.583	16.9	0.709	365	25.8	47.3	37.1	191 x 229 x 37
6.90	4.12	372	118	76.5	209	119	0.597	18.9	0.713	280	18.5	42.7	33.5	191 x 229 x 34
7.05	3.37	436	150	76.3	267	120	0.634	13.7	0.740	534	44.5	52.3	41.0	152 x 229 x 41
7.03	3.33	397	135	67.8	242	107	0.636	15.1	0.742	396	32.9	47.2	37.1	152 x 229 x 37
7.04	3.27	359	125	59.3	223	93.3	0.646	16.8	0.745	305	23.8	42.8	33.6	152 x 229 x 34
7.02	3.23	322	111	52.0	199	81.5	0.648	18.8	0.746	217	16.9	38.1	29.9	152 x 229 x 30
7.08	3.11	276	102	42.3	183	66.6	0.671	22.0	0.753	161	10.7	33.3	26.1	152 x 229 x 26

(*) Note, units are cm⁶ and not dm⁶.

Structural tees split from universal beams

Dimensions and Properties to BS4: Part 1: 1993

Properties have been calculated assuming that there is no loss of material due to splitting.

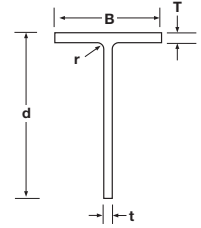

Designation Serial Size	Mass per metre kg/m	Cut from Universal Beam	Width of Section B mm	Depth of Section d mm	Thickness of		Root Radius r mm	Ratios for Local Buckling		Dimension C. cm	Second Moment of Area	
					Web t mm	Flange T mm		Flange B/2T	Web d/t		Axis x-x cm ⁴	Axis y-y cm ⁴
178 x 203 x 37	37.1	406 x 178 x 74	179.50	206.30	9.50	16.00	10.20	5.61	21.7	4.76	1740	773
178 x 203 x 34	33.5	406 x 178 x 67	178.80	204.60	8.80	14.30	10.20	6.25	23.3	4.73	1570	682
178 x 203 x 30	30.0	406 x 178 x 60	177.90	203.10	7.90	12.80	10.20	6.95	25.7	4.64	1400	602
178 x 203 x 27	27.0	406 x 178 x 54	177.70	201.20	7.70	10.90	10.20	8.15	26.1	4.83	1290	511
140 x 203 x 23	23.0	406 x 140 x 46	142.20	201.50	6.80	11.20	10.20	6.35	29.6	5.02	1120	269
140 x 203 x 20	19.5	406 x 140 x 39	141.80	198.90	6.40	8.60	10.20	8.24	31.1	5.32	979	205
171 x 178 x 34	33.5	356 x 171 x 67	173.20	181.60	9.10	15.70	10.20	5.52	20.0	4.00	1150	681
171 x 178 x 29	28.5	356 x 171 x 57	172.20	178.90	8.10	13.00	10.20	6.62	22.1	3.97	986	554
171 x 178 x 26	25.5	356 x 171 x 51	171.50	177.40	7.40	11.50	10.20	7.46	24.0	3.94	882	484
171 x 178 x 23	22.5	356 x 171 x 45	171.10	175.60	7.00	9.70	10.20	8.82	25.1	4.05	798	406
127 x 178 x 20	19.5	356 x 127 x 39	126.00	176.60	6.60	10.70	10.20	5.89	26.8	4.43	728	179
127 x 178 x 17	16.5	356 x 127 x 33	125.40	174.40	6.00	8.50	10.20	7.38	29.1	4.56	626	140
165 x 152 x 27	27.0	305 x 165 x 54	166.90	155.10	7.90	13.70	8.90	6.09	19.6	3.21	642	531
165 x 152 x 23	23.0	305 x 165 x 46	165.70	153.20	6.70	11.80	8.90	7.02	22.9	3.07	536	448
165 x 152 x 20	20.1	305 x 165 x 40	165.00	151.60	6.00	10.20	8.90	8.09	25.3	3.03	468	382
127 x 152 x 24	24.0	305 x 127 x 48	125.30	155.40	9.00	14.00	8.90	4.48	17.3	3.94	662	231
127 x 152 x 21	20.9	305 x 127 x 42	124.30	153.50	8.00	12.10	8.90	5.14	19.2	3.87	573	194
127 x 152 x 19	18.5	305 x 127 x 37	123.40	152.10	7.10	10.70	8.90	5.77	21.4	3.78	501	168
102 x 152 x 17	16.4	305 x 102 x 33	102.40	156.30	6.60	10.80	7.60	4.74	23.7	4.14	487	97.1
102 x 152 x 14	14.1	305 x 102 x 28	101.80	154.30	6.00	8.80	7.60	5.78	25.7	4.20	420	77.7
102 x 152 x 13	12.4	305 x 102 x 25	101.60	152.50	5.80	7.00	7.60	7.26	26.3	4.43	377	61.5
146 x 127 x 22	21.5	254 x 146 x 43	147.30	129.70	7.20	12.70	7.60	5.80	18.0	2.64	343	339
146 x 127 x 19	18.5	254 x 146 x 37	146.40	127.90	6.30	10.90	7.60	6.72	20.3	2.55	292	285
146 x 127 x 16	15.5	254 x 146 x 31	146.10	125.60	6.00	8.60	7.60	8.49	20.9	2.66	259	224
102 x 127 x 14	14.1	254 x 102 x 28	102.20	130.10	6.30	10.00	7.60	5.11	20.7	3.24	277	89.3
102 x 127 x 13	12.6	254 x 102 x 25	101.90	128.50	6.00	8.40	7.60	6.07	21.4	3.32	250	74.3
102 x 127 x 11	11.0	254 x 102 x 22	101.60	126.90	5.70	6.80	7.60	7.47	22.3	3.45	223	59.7
133 x 102 x 15	15.0	203 x 133 x 30	133.90	103.30	6.40	9.60	7.60	6.97	16.1	2.11	154	192
133 x 102 x 13	12.5	203 x 133 x 25	133.20	101.50	5.70	7.80	7.60	8.54	17.8	2.10	131	154

Structural tees split from universal beams

Dimensions and Properties to BS4: Part 1: 1993

Properties have been calculated assuming that there is no loss of material due to splitting.

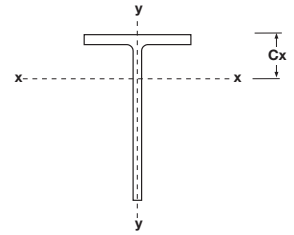

Radius of Gyration		Elastic Modulus			Plastic Modulus		Buckling Parameter u	Torsional Index x	Mono-symmetry Index Ψ	Warping Constant (*) H cm ⁶	Torsional Constant J cm ⁴	Area of Section cm ²	Designation	
Axis x-x cm	Axis y-y cm	Axis Flange x-x cm ³	Axis Toe x-x cm ³	Axis y-y cm ³	Axis x-x cm ³	Axis y-y cm ³							Mass per metre kg/m	Serial Size
6.06	4.04	365	109	86.1	194	133	0.555	13.8	0.696	350	31.3	47.2	37.1	178 x 203 x 37
6.07	3.99	332	100	76.3	177	118	0.561	15.2	0.698	262	23.0	42.8	33.5	178 x 203 x 34
6.04	3.97	301	89.0	67.6	157	104	0.561	16.9	0.699	186	16.6	38.3	30.0	178 x 203 x 30
6.13	3.85	268	84.6	57.5	150	89.1	0.588	19.2	0.705	146	11.5	34.5	27.0	178 x 203 x 27
6.19	3.03	224	74.2	37.8	132	59.0	0.633	19.5	0.740	93.7	9.49	29.3	23.0	140 x 203 x 23
6.28	2.87	184	67.2	28.9	121	45.4	0.668	23.8	0.750	66.3	5.33	24.8	19.5	140 x 203 x 20
5.20	3.99	288	81.5	78.6	145	121	0.500	12.2	0.672	249	27.8	42.7	33.5	171 x 178 x 34
5.21	3.91	248	70.9	64.4	125	99.4	0.514	14.4	0.676	154	16.6	36.3	28.5	171 x 178 x 29
5.21	3.86	224	63.9	56.5	113	87.1	0.521	16.1	0.677	110	11.9	32.4	25.5	171 x 178 x 26
5.28	3.76	197	59.1	47.4	104	73.3	0.546	18.4	0.683	79.2	7.90	28.7	22.5	171 x 178 x 23
5.41	2.68	164	55.0	28.4	98.0	44.5	0.632	17.6	0.739	57.1	7.53	24.9	19.5	127 x 178 x 20
5.45	2.58	137	48.6	22.3	87.2	35.1	0.655	21.1	0.746	38	4.38	21.1	16.5	127 x 178 x 17
4.32	3.93	200	52.2	63.7	92.8	97.8	0.389	11.8	0.636	128	17.3	34.4	27.0	165 x 152 x 27
4.27	3.91	174	43.7	54.1	77.1	82.8	0.380	13.6	0.636	78.6	11.1	29.4	23.0	165 x 152 x 23
4.27	3.86	155	38.6	46.3	67.6	70.9	0.393	15.5	0.638	52	7.35	25.7	20.1	165 x 152 x 20
4.65	2.74	168	57.1	36.8	102	58.0	0.602	11.7	0.714	104	15.8	30.6	24.0	127 x 152 x 24
4.63	2.70	148	49.9	31.3	88.9	49.2	0.606	13.3	0.716	69.2	10.5	26.7	20.9	127 x 152 x 21
4.61	2.67	132	43.8	27.2	77.9	42.7	0.606	14.9	0.718	47.4	7.36	23.6	18.5	127 x 152 x 19
4.82	2.15	118	42.3	19.0	75.8	30.0	0.656	15.8	0.749	36.8	6.08	20.9	16.4	102 x 152 x 17
4.84	2.08	100	37.4	15.3	67.5	24.2	0.673	18.7	0.756	25.2	3.69	17.9	14.1	102 x 152 x 14
4.88	1.97	85.0	34.8	12.1	63.9	19.4	0.705	21.8	0.766	20.4	2.37	15.8	12.4	102 x 152 x 13
3.54	3.52	130	33.2	46.0	59.5	70.5	0.202	10.6	0.613	64.9	11.9	27.4	21.5	146 x 127 x 22
3.52	3.48	115	28.5	39.0	50.7	59.7	0.233	12.2	0.616	41	7.65	23.6	18.5	146 x 127 x 19
3.61	3.36	97.4	26.2	30.6	46.0	47.1	0.376	14.8	0.623	24.5	4.26	19.8	15.5	146 x 127 x 16
3.92	2.22	85.5	28.3	17.5	50.4	27.4	0.607	13.8	0.720	21	4.77	18.0	14.1	102 x 127 x 14
3.95	2.15	75.3	26.2	14.6	46.9	23.0	0.628	15.8	0.727	15.9	3.20	16.0	12.6	102 x 127 x 13
3.99	2.06	64.5	24.1	11.7	43.5	18.6	0.656	18.2	0.735	12	2.06	14.0	11.0	102 x 127 x 11
2.84	3.17	73.1	18.8	28.7	33.5	44.1	-	10.7	0.569	21.7	5.13	19.1	15.0	133 x 102 x 15
2.86	3.10	62.4	16.2	23.1	28.7	35.5	-	12.8	0.572	12.6	2.97	16.0	12.5	133 x 102 x 13

- indicates that no u and x are given as there is no possibility of lateral torsional buckling due to bending about the x-x axis because the second moment of area about y-y axis exceeds the second moment of area about x-x axis.

(*) Note, units are cm⁶ and not dm⁶.

Structural tees split from universal columns

Dimensions and Properties to BS4: Part 1: 1993

Properties have been calculated assuming that there is no loss of material due to splitting.

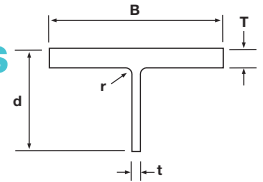

Designation Serial Size	Mass per metre kg/m	Cut from Universal Beam	Width of Section B mm	Depth of Section d mm	Thickness of		Root Radius r mm	Ratios for Local Buckling		Dimension C _x cm	Second Moment of Area	
					Web t mm	Flange T mm		Flange B/2T	Web d/t		Axis x-x cm ⁴	Axis y-y cm ⁴
305 x 152 x 79	79.0	305 x 305 x 158	311.20	163.50	15.80	25.00	15.20	6.22	10.3	3.04	1530	6280
305 x 152 x 69	68.4	305 x 305 x 137	309.20	160.20	13.80	21.70	15.20	7.12	11.6	2.86	1290	5350
305 x 152 x 59	58.9	305 x 305 x 118	307.40	157.20	12.00	18.70	15.20	8.22	13.1	2.69	1080	4530
305 x 152 x 49	48.4	305 x 305 x 97	305.30	153.90	9.90	15.40	15.20	9.91	15.5	2.50	858	3650
254 x 127 x 66	66.0	254 x 254 x 132	261.30	138.10	15.30	25.30	12.70	5.16	9.03	2.70	871	3770
254 x 127 x 54	53.5	254 x 254 x 107	258.80	133.30	12.80	20.50	12.70	6.31	10.4	2.45	676	2960
254 x 127 x 45	44.4	254 x 254 x 89	256.30	130.10	10.30	17.30	12.70	7.41	12.6	2.21	524	2430
254 x 127 x 37	36.5	254 x 254 x 73	254.60	127.00	8.60	14.20	12.70	8.96	14.8	2.05	417	1950
203 x 102 x 43	43.0	203 x 203 x 86	209.10	111.00	12.70	20.50	10.20	5.10	8.74	2.20	373	1560
203 x 102 x 36	35.5	203 x 203 x 71	206.40	107.80	10.00	17.30	10.20	5.97	10.8	1.95	280	1270
203 x 102 x 30	30.0	203 x 203 x 60	205.80	104.70	9.40	14.20	10.20	7.25	11.1	1.89	244	1030
203 x 102 x 26	26.0	203 x 203 x 52	204.30	103.00	7.90	12.50	10.20	8.17	13.0	1.75	200	889
203 x 102 x 23	23.0	203 x 203 x 46	203.60	101.50	7.20	11.00	10.20	9.25	14.1	1.69	177	774
152 x 76 x 19	18.5	152 x 152 x 37	154.40	80.80	8.00	11.50	7.60	6.71	10.1	1.53	93.1	353
152 x 76 x 15	15.0	152 x 152 x 30	152.90	78.70	6.50	9.40	7.60	8.13	12.1	1.41	72.2	280
152 x 76 x 12	11.5	152 x 152 x 23	152.20	76.10	5.80	6.80	7.60	11.2	13.1	1.39	58.5	200

Structural tees split from universal columns

Dimensions and Properties to BS4: Part 1: 1993

Properties have been calculated assuming that there is no loss of material due to splitting.

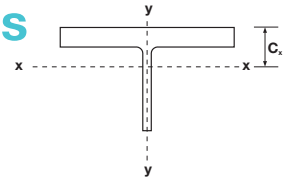

Radius of Gyration		Elastic Modulus			Plastic Modulus		Mono-symmetry Index Ψ	Warping Constant (*) H cm ⁶	Torsional Constant J cm ⁴	Area of Section cm ²	Mass per metre kg/m	Designation	
Axis x-x cm	Axis y-y cm	Flange Axis x-x cm ³	Toe Axis x-x cm ³	Axis y-y cm ³	Axis x-x cm ³	Axis y-y cm ³						Serial Size	
3.90	7.90	503	115	404	225	615	0.268	3650	188	101	79.0	305 x 152 x 79	
3.84	7.83	450	97.7	346	188	526	0.263	2340	124	87.2	68.4	305 x 152 x 69	
3.79	7.77	401	82.8	295	156	448	0.262	1470	80.3	75.1	58.9	305 x 152 x 59	
3.73	7.69	343	66.5	239	123	363	0.258	806	45.5	61.7	48.4	305 x 152 x 49	
3.22	6.69	323	78.3	288	159	439	0.25	2200	159	84.1	66.0	254 x 127 x 66	
3.15	6.59	276	62.1	229	122	349	0.245	1150	85.9	68.2	53.5	254 x 127 x 54	
3.04	6.55	237	48.5	190	94.0	288	0.242	660	51.1	56.7	44.4	254 x 127 x 45	
2.99	6.48	204	39.2	153	74.0	233	0.236	359	28.8	46.5	36.5	254 x 127 x 37	
2.61	5.34	169	41.9	150	84.6	228	0.257	605	68.1	54.8	43.0	203 x 102 x 43	
2.49	5.30	143	31.8	123	63.6	187	0.254	343	40.0	45.2	35.5	203 x 102 x 36	
2.53	5.20	129	28.4	100	54.3	153	0.245	195	23.5	38.2	30.0	203 x 102 x 30	
2.46	5.18	115	23.4	87.0	44.5	132	0.243	128	15.8	33.1	26.0	203 x 102 x 26	
2.45	5.13	105	20.9	76.0	39.0	115	0.242	87.2	11.0	29.4	23.0	203 x 102 x 23	
1.99	3.87	60.7	14.2	45.7	27.1	69.8	0.277	44.9	9.54	23.5	18.5	152 x 76 x 19	
1.94	3.83	51.4	11.2	36.7	20.9	55.8	0.269	23.7	5.24	19.1	15.0	152 x 76 x 15	
2.00	3.70	41.9	9.41	26.3	16.9	40.1	0.278	9.78	2.30	14.6	11.5	152 x 76 x 12	

(*) Note, units are cm⁶ and not dm⁶.

Values of u and x are not given as lateral torsional buckling due to bending about the x - x axis is not possible, this is because the second moment of area about the y - y exceeds the second moment of area about the x - x axis.

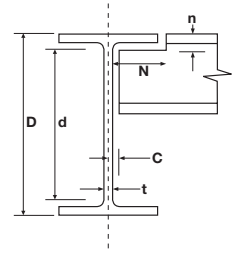

Universal beams

Dimensions for detailing and surface areas to BS4: Part 1: 1993

Designation	End Clearance C mm	Notch		Surface Area		
		N mm	n mm	per metre m ²	per tonne m ²	two end faces m ²
Serial Size						
† 1016 x 305 x 487	17	150	86	3.19	6.56	0.124
† 1016 x 305 x 437	15	150	80	3.17	7.25	0.111
† 1016 x 305 x 393	14	150	74	3.14	8.00	0.100
† 1016 x 305 x 349	13	152	70	3.13	8.96	0.0890
† 1016 x 305 x 314	12	152	66	3.11	9.89	0.0800
† 1016 x 305 x 272	10	152	62	3.10	11.4	0.0694
† 1016 x 305 x 249	10	152	56	3.08	12.4	0.0634
† 1016 x 305 x 222	10	152	52	3.06	13.8	0.0566
914 x 419 x 388	13	210	62	3.44	8.87	0.0988
914 x 419 x 343	12	210	58	3.42	9.96	0.0874
914 x 305 x 289	12	156	52	3.01	10.4	0.0736
914 x 305 x 253	11	156	48	2.99	11.8	0.0646
914 x 305 x 224	10	156	44	2.97	13.2	0.0572
914 x 305 x 201	10	156	40	2.96	14.7	0.0512
838 x 292 x 226	10	150	46	2.81	12.4	0.0578
838 x 292 x 194	9	150	40	2.79	14.4	0.0494
838 x 292 x 176	9	150	38	2.78	15.8	0.0448
762 x 267 x 197	10	138	42	2.55	13.0	0.0502
762 x 267 x 173	9	138	40	2.53	14.6	0.0440
762 x 267 x 147	8	138	34	2.51	17.1	0.0374
762 x 267 x 134	8	138	32	2.51	18.7	0.0342
686 x 254 x 170	9	132	40	2.35	13.8	0.0434
686 x 254 x 152	9	132	38	2.34	15.4	0.0388
686 x 254 x 140	8	132	36	2.33	16.6	0.0356
686 x 254 x 125	8	132	32	2.32	18.5	0.0318
610 x 305 x 238	11	158	48	2.45	10.3	0.0606
610 x 305 x 179	9	158	42	2.41	13.5	0.0456
610 x 305 x 149	8	158	38	2.39	16.0	0.0380
610 x 229 x 140	9	120	36	2.11	15.1	0.0356
610 x 229 x 125	8	120	34	2.09	16.7	0.0318
610 x 229 x 113	8	120	30	2.08	18.4	0.0288
610 x 229 x 101	7	120	28	2.07	20.5	0.0258
533 x 210 x 122	8	110	34	1.89	15.5	0.0310
533 x 210 x 109	8	110	32	1.88	17.2	0.0278
533 x 210 x 101	7	110	32	1.87	18.5	0.0258
533 x 210 x 92	7	110	30	1.86	20.2	0.0234
533 x 210 x 82	7	110	26	1.85	22.5	0.0210
457 x 191 x 98	8	102	30	1.67	17.0	0.0250
457 x 191 x 89	7	102	28	1.66	18.6	0.0228
457 x 191 x 82	7	102	28	1.65	20.1	0.0208
457 x 191 x 74	7	102	26	1.64	22.1	0.0189
457 x 191 x 67	6	102	24	1.63	24.3	0.0171

† These dimensions are in addition to our standard range to BS4 specifications.

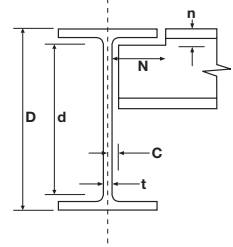

Universal beams

Dimensions for detailing and surface areas to BS4: Part 1: 1993

Designation	End Clearance C mm	Notch		Surface Area		
		N mm	n mm	per metre m ²	per tonne m ²	two end faces m ²
Serial Size						
457 x 152 x 82	7	84	30	1.51	18.4	0.0210
457 x 152 x 74	7	84	28	1.50	20.2	0.0189
457 x 152 x 67	7	84	26	1.50	22.3	0.0171
457 x 152 x 60	6	84	24	1.49	24.9	0.0152
457 x 152 x 52	6	84	22	1.48	28.3	0.0133
406 x 178 x 74	7	96	28	1.51	20.4	0.0189
406 x 178 x 67	6	96	26	1.50	22.3	0.0171
406 x 178 x 60	6	96	24	1.49	24.8	0.0153
406 x 178 x 54	6	96	22	1.48	27.3	0.0138
406 x 140 x 46	5	78	22	1.34	29.1	0.0117
406 x 140 x 39	5	78	20	1.33	34.1	0.0099
356 x 171 x 67	7	94	26	1.38	20.6	0.0171
356 x 171 x 57	6	94	24	1.37	24.1	0.0145
356 x 171 x 51	6	94	22	1.36	26.7	0.0130
356 x 171 x 45	6	94	20	1.36	30.2	0.0115
356 x 127 x 39	5	70	22	1.18	30.2	0.0100
356 x 127 x 33	5	70	20	1.17	35.4	0.0084
305 x 165 x 54	6	90	24	1.26	23.3	0.0138
305 x 165 x 46	5	90	22	1.25	27.1	0.0117
305 x 165 x 40	5	90	20	1.24	30.8	0.0103
305 x 127 x 48	7	70	24	1.09	22.7	0.0122
305 x 127 x 42	6	70	22	1.08	25.8	0.0107
305 x 127 x 37	6	70	20	1.07	28.9	0.0094
305 x 102 x 33	5	58	20	1.01	30.8	0.0084
305 x 102 x 28	5	58	18	1.00	35.5	0.0072
305 x 102 x 25	5	58	16	0.992	40.0	0.0063
254 x 146 x 43	6	82	22	1.08	25.1	0.0110
254 x 146 x 37	5	82	20	1.07	28.9	0.0094
254 x 146 x 31	5	82	18	1.06	34.0	0.0079
254 x 102 x 28	5	58	18	0.904	31.9	0.0072
254 x 102 x 25	5	58	16	0.897	35.7	0.0064
254 x 102 x 22	5	58	16	0.890	40.5	0.0056
203 x 133 x 30	5	74	18	0.923	30.8	0.0076
203 x 133 x 25	5	74	16	0.915	36.5	0.0064
203 x 102 x 23	5	60	18	0.790	34.2	0.0059
178 x 102 x 19	4	60	16	0.738	38.7	0.0049
152 x 89 x 16	4	54	16	0.638	40.0	0.0041
127 x 76 x 13	4	46	16	0.537	41.4	0.0033

The Dimension $n = \frac{D-d}{2}$ to the nearest 2mm above. The Dimension $C = t/2 + 2$ mm to the nearest 1mm.

Universal columns

Dimensions for detailing and surface areas to BS4: Part 1: 1993

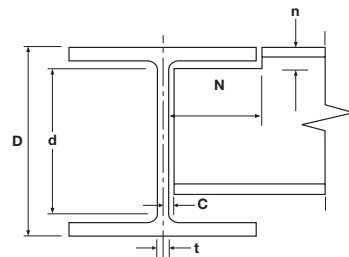

Designation Serial Size	End Clearance C mm	Notch		Surface Area		
		N mm	n mm	per metre m ²	per tonne m ²	two end faces m ²
356 x 406 x 634	26	200	94	2.52	3.98	0.162
356 x 406 x 551	23	200	84	2.47	4.48	0.140
356 x 406 x 467	20	200	74	2.42	5.18	0.119
356 x 406 x 393	17	200	66	2.38	6.06	0.100
356 x 406 x 340	15	200	60	2.35	6.91	0.0866
356 x 406 x 287	13	200	52	2.31	8.05	0.0732
356 x 406 x 235	11	200	46	2.28	9.70	0.0598
356 x 368 x 202	10	190	44	2.19	10.8	0.0514
356 x 368 x 177	9	190	40	2.17	12.3	0.0452
356 x 368 x 153	8	190	36	2.16	14.1	0.0390
356 x 368 x 129	7	190	34	2.14	16.6	0.0328
305 x 305 x 283	15	158	60	1.94	6.86	0.0720
305 x 305 x 240	14	158	54	1.91	7.96	0.0612
305 x 305 x 198	12	158	48	1.87	9.44	0.0504
305 x 305 x 158	10	158	42	1.84	11.6	0.0402
305 x 305 x 137	9	158	38	1.82	13.3	0.0348
305 x 305 x 118	8	158	34	1.81	15.4	0.0300
305 x 305 x 97	7	158	32	1.79	18.5	0.0246
254 x 254 x 167	12	134	46	1.58	9.46	0.0426
254 x 254 x 132	10	134	38	1.55	11.7	0.0336
254 x 254 x 107	8	134	34	1.52	14.2	0.0272
254 x 254 x 89	7	134	30	1.50	16.9	0.0226
254 x 254 x 73	6	134	28	1.49	20.4	0.0186
203 x 203 x 86	8	110	32	1.24	14.4	0.0220
203 x 203 x 71	7	110	28	1.22	17.2	0.0181
203 x 203 x 60	7	110	26	1.21	20.2	0.0153
203 x 203 x 52	6	110	24	1.20	23.1	0.0133
203 x 203 x 46	6	110	22	1.19	25.8	0.0117
152 x 152 x 37	6	84	20	0.912	24.7	0.0094
152 x 152 x 30	5	84	18	0.901	30.0	0.0077
152 x 152 x 23	5	84	16	0.889	38.7	0.0058

Please consult with CORUS for availability. See page 46 of 3.

The Dimension $n = \frac{D-d}{2}$ to the nearest 2mm above. The Dimension $C = t/2 + 2\text{mm}$ to the nearest 1mm.

The Dimension N is based upon the outstand from web face to flange edge +10mm, to the nearest 2mm above and makes due allowance for rolling tolerance.

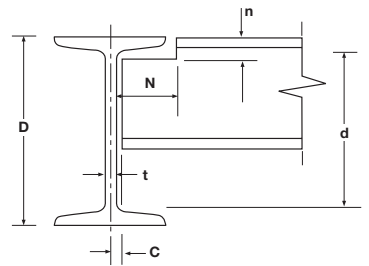

Joists

Dimensions for detailing and surface areas to BS4: Part 1: 1993

Designation	End Clearance C mm	Notch		Surface Area		
		N mm	n mm	per metre m ²	per tonne m ²	two end faces m ²
203 x 152 x 52	6	78	36	0.932	17.8	0.0133
152 x 127 x 37	7	66	30	0.737	19.8	0.0095

The Dimension **N** is equal to the outstand from web face edge +6mm, to the nearest 2mm above.

The Dimension **n** = $\frac{D-d}{2}$ to the nearest 2mm above. The Dimension **C** = $t/2 + 2$ mm to the nearest 1mm.

All joists subject to viable mount size. Please refer to Account Manager.

Parallel flange channels

Dimensions for detailing and surface areas to BS4: Part 1: 1993

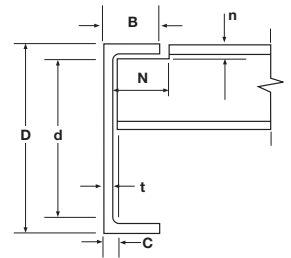

Designation	End Clearance C mm	Notch		Surface Area		
		N mm	n mm	per metre m ²	per tonne m ²	two end faces m ²
430 x 100 x 64	13	96	36	1.23	19.1	0.0164
380 x 100 x 54	12	98	34	1.13	20.9	0.0137
300 x 100 x 46	11	98	32	0.969	21.3	0.0116
300 x 90 x 41	11	88	28	0.932	22.5	0.0105
260 x 90 x 35	10	88	28	0.854	24.5	0.0089
260 x 75 x 28	9	74	26	0.796	28.8	0.0070
230 x 90 x 32	10	90	28	0.795	24.7	0.0082
230 x 75 x 26	9	76	26	0.737	28.7	0.0065
200 x 90 x 30	9	90	28	0.736	24.8	0.0076
200 x 75 x 23	8	76	26	0.678	29.0	0.0060
180 x 90 x 26	9	90	26	0.697	26.7	0.0066
180 x 75 x 20	8	76	24	0.638	31.4	0.0052
150 x 90 x 24	9	90	26	0.637	26.7	0.0061
150 x 75 x 18	8	76	24	0.579	32.3	0.0046
125 x 65 x 15	8	66	22	0.489	33.0	0.0038
100 x 50 x 10	7	52	18	0.382	37.5	0.0026

The Dimension **N** is equal to **(B-t) + 6**mm (rounded up to a multiple of 2mm). The Dimension **n** is equal to $\frac{D-d}{2}$ (taken to the next higher multiple of 2mm)

The Dimension **C** is equal to **t + 2**mm (rounded up to the nearest mm)

Equal and unequal angles

Surface areas to BSEN: 10056-1: 1999

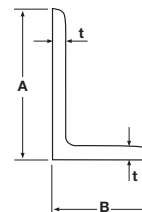
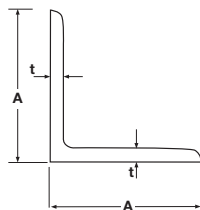

EQUAL ANGLES

Designation Serial Size A x A x t mm x mm x mm	Surface Area	
	per metre m ²	per tonne m ²
200 x 200 x 24	0.78	11.03
200 x 200 x 20	0.78	13.09
200 x 200 x 18	0.78	14.46
200 x 200 x 16	0.78	16.18
† 150 x 150 x 18	0.59	14.63
150 x 150 x 15	0.59	17.36
150 x 150 x 12	0.59	21.44
150 x 150 x 10	0.59	25.51
† 120 x 120 x 15	0.47	17.60
120 x 120 x 12	0.47	21.69
120 x 120 x 10	0.47	25.76
† 120 x 120 x 8	0.47	31.87
† 100 x 100 x 15	0.39	17.79
100 x 100 x 12	0.39	21.86
100 x 100 x 10	0.39	25.92
100 x 100 x 8	0.39	32.00
† 90 x 90 x 12	0.35	22.01
90 x 90 x 10	0.35	26.07
90 x 90 x 8	0.35	32.15
90 x 90 x 7	0.35	36.48

UNEQUAL ANGLES

Designation Serial Size A x B x t mm x mm x mm	Surface Area	
	per metre m ²	per tonne m ²
200 x 150 x 18	0.69	14.59
200 x 150 x 15	0.69	17.34
200 x 150 x 12	0.69	21.45
200 x 100 x 15	0.59	17.40
200 x 100 x 12	0.59	21.49
200 x 100 x 10	0.59	25.58
150 x 90 x 15	0.47	17.65
150 x 90 x 12	0.47	21.75
150 x 90 x 10	0.47	25.84
150 x 75 x 15	0.44	17.69
150 x 75 x 12	0.44	21.78
150 x 75 x 10	0.44	25.87
125 x 75 x 12	0.39	21.93
125 x 75 x 10	0.39	26.01
125 x 75 x 8	0.39	32.12
100 x 75 x 12	0.34	22.11
100 x 75 x 10	0.34	26.19
100 x 75 x 8	0.34	32.29
100 x 65 x 10	0.32	26.23
100 x 65 x 8	0.32	32.32
100 x 65 x 7	0.32	36.66



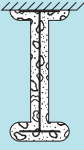
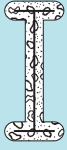
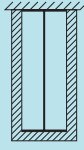
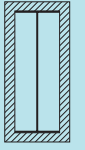

Universal beams

Hp/A values

Designation	Hp/A ratio (m ⁻¹)			
				
Serial Size	Profile 3 Sides	Profile 4 Sides	Box 3 Sides	Box 4 Sides
1016 x 305 x 487	45	50	40	45
1016 x 305 x 437	50	55	40	50
1016 x 305 x 393	55	65	45	55
1016 x 305 x 349	65	70	50	60
1016 x 305 x 314	70	80	55	65
1016 x 305 x 272	80	90	65	75
1016 x 305 x 249	90	95	70	80
1016 x 305 x 222	95	110	80	90
914 x 419 x 388	60	70	45	55
914 x 419 x 343	70	80	50	60
914 x 305 x 289	75	80	60	65
914 x 305 x 253	85	95	65	75
914 x 305 x 224	95	105	75	85
914 x 305 x 201	105	115	80	95
838 x 292 x 226	85	100	70	80
838 x 292 x 194	100	115	80	90
838 x 292 x 176	110	125	90	100
762 x 267 x 197	90	100	70	85
762 x 267 x 173	105	115	80	95
762 x 267 x 147	120	135	95	110
762 x 267 x 134	130	145	105	120
686 x 254 x 170	95	110	75	90
686 x 254 x 152	105	120	85	95
686 x 254 x 140	115	130	90	105
686 x 254 x 125	130	145	100	115
610 x 305 x 238	70	80	50	60
610 x 305 x 179	90	105	70	80
610 x 305 x 149	110	125	80	95
610 x 229 x 140	105	120	80	95
610 x 229 x 125	115	130	90	105
610 x 229 x 113	130	145	100	115
610 x 229 x 101	145	160	110	130
533 x 210 x 122	110	120	85	95
533 x 210 x 109	120	135	95	110
533 x 210 x 101	130	145	100	115
533 x 210 x 92	140	160	110	125
533 x 210 x 82	155	175	120	140
457 x 191 x 98	120	135	90	105
457 x 191 x 89	130	145	100	115
457 x 191 x 82	140	160	105	125
457 x 191 x 74	155	175	115	135
457 x 191 x 67	170	190	130	150





Universal beams

Hp/A values

Designation	Hp/A ratio (m ⁻¹)			
				
Serial Size	Profile 3 Sides	Profile 4 Sides	Box 3 Sides	Box 4 Sides
457 x 152 x 82	130	145	105	120
457 x 152 x 74	145	160	115	130
457 x 152 x 67	155	175	125	145
457 x 152 x 60	175	195	140	160
457 x 152 x 52	200	220	160	180
406 x 178 x 74	140	160	105	125
406 x 178 x 67	155	175	115	140
406 x 178 x 60	170	195	130	155
406 x 178 x 54	190	215	145	170
406 x 140 x 46	205	230	160	185
406 x 140 x 39	240	270	190	215
356 x 171 x 67	140	160	105	125
356 x 171 x 57	165	190	120	145
356 x 171 x 51	185	210	135	160
356 x 171 x 45	205	235	150	180
356 x 127 x 39	210	235	165	195
356 x 127 x 33	250	280	195	225
305 x 165 x 54	160	185	115	140
305 x 165 x 46	185	210	135	160
305 x 165 x 40	210	240	150	185
305 x 127 x 48	160	180	120	145
305 x 127 x 42	180	200	140	160
305 x 127 x 37	200	225	155	180
305 x 102 x 33	215	240	175	200
305 x 102 x 28	250	280	200	230
305 x 102 x 25	280	315	225	255
254 x 146 x 43	170	195	120	150
254 x 146 x 37	195	225	140	170
254 x 146 x 31	230	270	165	200
254 x 102 x 28	220	250	175	200
254 x 102 x 25	250	280	190	225
254 x 102 x 22	280	320	220	255
203 x 133 x 30	205	240	145	180
203 x 133 x 25	245	285	170	210
203 x 102 x 23	235	270	175	205
178 x 102 x 19	260	305	190	230
152 x 89 x 16	270	315	195	235
127 x 76 x 13	280	325	200	245

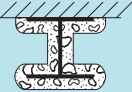

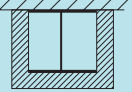

Universal columns

Hp/A values

Designation Serial Size	Hp/A ratio (m ⁻¹)			
	 Profile 3 Sides	 Profile 4 Sides	 Box 3 Sides	 Box 4 Sides
356 x 406 x 634	30	35	20	25
356 x 406 x 551	30	35	20	25
356 x 406 x 467	35	40	20	30
356 x 406 x 393	40	50	25	35
356 x 406 x 340	45	55	30	35
356 x 406 x 287	50	65	30	45
356 x 406 x 235	65	75	40	50
356 x 368 x 202	70	85	45	60
356 x 368 x 177	80	95	50	65
356 x 368 x 153	90	110	55	75
356 x 368 x 129	110	130	65	90
305 x 305 x 283	45	55	30	40
305 x 305 x 240	50	60	35	45
305 x 305 x 198	60	75	40	50
305 x 305 x 158	75	90	50	65
305 x 305 x 137	85	105	55	70
305 x 305 x 118	100	120	60	85
305 x 305 x 97	120	145	75	100
254 x 254 x 167	60	75	40	50
254 x 254 x 132	75	90	50	65
254 x 254 x 107	95	110	60	75
254 x 254 x 89	110	135	70	90
254 x 254 x 73	130	160	80	110
203 x 203 x 86	95	115	60	80
203 x 203 x 71	110	135	70	95
203 x 203 x 60	130	160	80	110
203 x 203 x 52	150	180	95	125
203 x 203 x 46	170	200	105	140
152 x 152 x 37	160	195	100	135
152 x 152 x 30	195	235	120	160
152 x 152 x 23	250	305	155	210

Joists









Hp/A values

Designation	Hp/A ratio (m ⁻¹)			
	 Profile 3 Sides	 Profile 4 Sides	 Box 3 Sides	 Box 4 Sides
203 x 152 x 52	115	140	85	105
152 x 127 x 37	130	155	90	120

All joists subject to viable mount size. Please consult with Series for availability. See page 12/13.

Parallel flange channels





Hp/A values

Designation	Hp/A ratio (m ⁻¹)							
	 Profile 3 Sides	 Profile 3 Sides	 Profile 3 Sides	 Profile 4 Sides	 Box 3 Sides	 Box 3 Sides	 Box 3 Sides	 Box 4 Sides
430 x 100 x 64	135	95	75	150	115	75	75	130
380 x 100 x 54	150	110	85	165	125	85	85	140
300 x 100 x 46	150	115	85	165	120	85	85	140
300 x 90 x 41	160	120	90	175	130	90	90	150
260 x 90 x 35	170	135	100	190	135	100	100	160
260 x 75 x 28	205	150	115	225	170	115	115	190
230 x 90 x 32	170	140	100	195	135	100	100	155
230 x 75 x 26	200	155	115	225	165	115	115	185
200 x 90 x 30	170	140	100	195	130	100	100	155
200 x 75 x 23	200	160	115	225	160	115	115	185
180 x 90 x 26	185	155	110	210	135	110	110	165
180 x 75 x 20	215	175	125	245	170	125	125	195
150 x 90 x 24	180	160	110	210	130	110	110	160
150 x 75 x 18	220	190	130	255	165	130	130	200
125 x 65 x 15	225	195	135	260	170	135	135	200
100 x 50 x 10	255	215	155	295	190	155	155	230

* Root Radius included in calculations

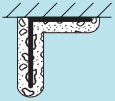
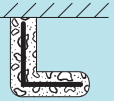

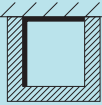
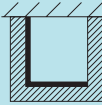







Equal angles

Hp/A Values

Designation	Hp/A ratio (m ⁻¹)					
						
Serial Size	Profile 3 Sides	Profile 3 Sides	Profile 4 Sides	Box 3 Sides	Box 3 Sides	Box 4 Sides
A x A x t mm x mm x mm						
200 x 200 x 24	65	85	85	65	65	90
200 x 200 x 20	75	100	105	80	80	105
200 x 200 x 18	85	110	115	85	85	115
200 x 200 x 16	95	125	125	95	95	130
150 x 150 x 18	85	115	115	90	90	120
150 x 150 x 15	100	135	135	105	105	140
150 x 150 x 12	125	165	170	130	130	170
150 x 150 x 10	150	200	200	155	155	205
120 x 120 x 15	105	135	140	105	105	140
120 x 120 x 12	125	170	170	130	130	175
120 x 120 x 10	150	200	200	155	155	205
120 x 120 x 8	185	250	250	190	190	255
100 x 100 x 15	105	135	140	110	110	145
100 x 100 x 12	130	170	170	130	130	175
100 x 100 x 10	150	200	205	155	155	210
100 x 100 x 8	185	250	250	195	195	260
90 x 90 x 12	130	170	175	135	135	175
90 x 90 x 10	150	200	205	160	160	210
90 x 90 x 8	190	250	250	195	195	260
90 x 90 x 7	215	285	285	220	220	295

Unequal angles

Hp/A Values

Designation Serial Size A x B x t mm x mm x mm	Hp/A ratio (m ⁻¹)									
	 Profile 3 Sides	 Profile 3 Sides	 Profile 3 Sides	 Profile 3 Sides	 Profile 4 Sides	 Box 3 Sides	 Box 3 Sides	 Box 3 Sides	 Box 3 Sides	 Box 4 Sides
200 x 150 x 18	115	115	90	80	115	90	85	90	85	115
200 x 150 x 15	135	135	105	95	135	110	100	110	100	140
200 x 150 x 12	165	165	130	120	170	135	125	135	125	170
200 x 100 x 15	135	135	115	90	135	115	95	115	95	140
200 x 100 x 12	165	165	140	110	170	145	115	145	115	170
200 x 100 x 10	200	200	165	130	200	170	135	170	135	205
150 x 90 x 15	135	135	110	95	140	115	95	115	95	140
150 x 90 x 12	170	170	140	115	170	140	120	140	120	175
150 x 90 x 10	200	200	165	140	205	170	145	170	145	205
150 x 75 x 15	135	135	115	90	140	120	95	120	95	140
150 x 75 x 12	170	170	140	115	170	145	115	145	115	175
150 x 75 x 10	200	200	170	135	205	175	140	175	140	210
125 x 75 x 12	170	170	140	115	170	145	120	145	120	175
125 x 75 x 10	200	200	165	140	205	170	145	170	145	210
125 x 75 x 8	250	250	205	170	250	210	180	210	180	260
100 x 75 x 12	170	170	135	125	175	140	125	140	125	180
100 x 75 x 10	205	205	160	145	205	165	150	165	150	210
100 x 75 x 8	250	250	200	180	255	205	185	205	185	260
100 x 65 x 10	205	205	165	140	205	170	145	170	145	210
100 x 65 x 8	250	250	200	175	255	210	180	210	180	260
100 x 65 x 7	285	285	230	200	290	235	205	235	205	295







Structural tees split from universal beams

Hp/A Values

Designation	Hp/A ratio (m ⁻¹)					
						
Serial Size	Profile 3 Sides	Profile 3 Sides	Profile 4 Sides	Box 3 Sides	Box 3 Sides	Box 4 Sides
254 x 343 x 63	115	145	145	115	115	150
305 x 305 x 90	80	105	105	80	80	110
305 x 305 x 75	95	125	125	95	95	130
229 x 305 x 70	95	120	120	95	95	120
229 x 305 x 63	105	130	135	105	105	135
229 x 305 x 57	115	145	145	115	115	150
229 x 305 x 51	125	160	160	130	130	165
210 x 267 x 61	95	120	125	95	95	125
210 x 267 x 55	105	135	135	110	110	140
210 x 267 x 51	115	145	145	115	115	150
210 x 267 x 46	125	160	160	125	125	160
210 x 267 x 41	140	175	180	140	140	180
191 x 229 x 49	105	135	135	105	105	135
191 x 229 x 45	115	145	145	115	115	150
191 x 229 x 41	125	160	160	125	125	160
191 x 229 x 37	135	175	175	135	135	175
191 x 229 x 34	150	190	195	150	150	195
152 x 229 x 41	115	145	145	120	120	150
152 x 229 x 37	130	160	160	130	130	165
152 x 229 x 34	140	175	175	145	145	180
152 x 229 x 30	155	195	195	160	160	200
152 x 229 x 26	180	220	225	180	180	225







Structural tees split from universal beams

Hp/A Values

Designation	Hp/A ratio (m ³)					
						
Serial Size	Profile 3 Sides	Profile 3 Sides	Profile 4 Sides	Box 3 Sides	Box 3 Sides	Box 4 Sides
178 x 203 x 37	125	160	160	125	125	165
178 x 203 x 34	135	175	175	140	140	180
178 x 203 x 30	150	195	195	155	155	200
178 x 203 x 27	165	215	215	170	170	220
140 x 203 x 23	185	230	230	185	185	235
140 x 203 x 20	215	270	270	215	215	275
171 x 178 x 34	125	160	165	125	125	165
171 x 178 x 29	145	190	190	145	145	195
171 x 178 x 26	160	210	210	160	160	215
171 x 178 x 23	180	235	240	180	180	240
127 x 178 x 20	190	235	240	195	195	245
127 x 178 x 17	220	280	280	225	225	285
165 x 152 x 27	135	185	185	140	140	185
165 x 152 x 23	160	210	215	160	160	215
165 x 152 x 20	180	240	245	185	185	245
127 x 152 x 24	140	180	180	140	140	185
127 x 152 x 21	160	200	205	160	160	210
127 x 152 x 19	180	225	230	180	180	235
102 x 152 x 17	195	240	245	200	200	245
102 x 152 x 14	225	280	280	230	230	285
102 x 152 x 13	255	315	320	255	255	320
146 x 127 x 22	145	195	200	150	150	200
146 x 127 x 19	170	225	230	170	170	235
146 x 127 x 16	195	270	270	200	200	275
102 x 127 x 14	195	250	255	200	200	260
102 x 127 x 13	220	280	285	225	225	290
102 x 127 x 11	250	320	320	255	255	325
133 x 102 x 15	175	240	245	180	180	250
133 x 102 x 13	205	285	290	210	210	295

Structural tees split from universal columns

Hp/A Values

Designation	Hp/A ratio (m ⁻¹)					
	 Profile 3 Sides	 Profile 3 Sides	 Profile 4 Sides	 Box 3 Sides	 Box 3 Sides	 Box 4 Sides
Serial Size						
305 x 152 x 79	60	90	95	65	65	95
305 x 152 x 69	70	105	105	70	70	110
305 x 152 x 59	80	120	120	85	85	125
305 x 152 x 49	95	145	145	100	100	150
254 x 127 x 66	65	90	95	65	65	95
254 x 127 x 54	75	110	115	75	75	115
254 x 127 x 45	90	135	135	90	90	135
254 x 127 x 37	105	160	160	110	110	165
203 x 102 x 43	75	115	115	80	80	115
203 x 102 x 36	90	135	135	95	95	140
203 x 102 x 30	105	160	160	110	110	165
203 x 102 x 26	120	180	185	125	125	185
203 x 102 x 23	135	200	205	140	140	210
152 x 76 x 19	130	195	195	135	135	200
152 x 76 x 15	160	235	240	160	160	240
152 x 76 x 12	205	305	310	210	210	310

Product specifications/ tolerances

The dimensions and mass of the following hot-rolled structural steel sections currently produced by Corus – universal beams, universal columns, universal bearing piles, joists, parallel flange channels, structural tees cut from universal beams, structural tees cut from universal columns, as well as length, depth and mass tolerances for taper flange joists are specified in BS4: Part 1: 1993.

Rolling tolerances – BS EN 10034: 1993

This European Standard specifies tolerances on shape dimensions and mass of structural steel universal beams and columns. These requirements do not apply to taper flange sections.

Section height (*h*)

The deviation from nominal on section height measured at the centre line of web thickness shall be within the tolerance given in Table 1(a).

Table 1 (a) Tolerance on height and cross-section

Section height <i>h</i> mm	Tolerance mm
Up to and including 180	+3.0 -2.0
Greater than 180 up to and including 400	+4.0 -2.0
Greater than 400 up to and including 700	+5.0 -3.0
Greater than 700	± 5.0

Flange width (*b*)

The deviation from nominal on flange width shall be within the tolerance given in Table 1(b).

Table 1 (b) Tolerance on flange width

Flange width <i>b</i> mm	Tolerance mm
Up to and including 110	+4.0 -1.0
Greater than 110 up to and including 210	+4.0 -2.0
Greater than 210 up to and including 325	± 4.0
Greater than 325	+6.0 -5.0

Web thickness (*s*)

The deviation from nominal on web thickness measured at the mid-point of dimension (*h*) shall be within the tolerance given in Table 1(c)

Table 1 (c) Tolerances on web thickness

Web thickness <i>s</i> mm	Tolerance mm
Less than 7	± 0.7
7 up to but excluding 10	± 1.0
10 up to but excluding 20	± 1.5
20 up to but excluding 40	± 2.0
40 up to but excluding 60	± 2.5
60 and over	± 3.0

Flange thickness (*t*)

The deviation from nominal on flange thickness measured at the quarter flange width point shall be within the tolerance given in Table 1(d)

Table 1 (d) Tolerances on flange thickness

Flange thickness <i>t</i> mm	Tolerance mm
Less than 6.5	+1.5 -0.5
6.5 up to but excluding 10	+2.0 -1.0
10 up to but excluding 20	+2.5 -1.5
20 up to but excluding 30	+2.5 -2.0
30 up to but excluding 40	± 2.5
40 up to but excluding 60	± 3.0
60 and over	± 4.0

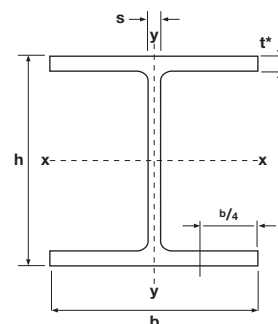

*t** is measured at *b/4*

Out-of-squareness ($k + k'$)

The out-of-squareness of the section shall not exceed the maximum given in Table 2(a).

Table 2 (a) Tolerance on out-of-squareness of universal beams and columns

Flange width b mm	Tolerance mm
Up to and including 110	1.5
Greater than 110	2% of b (maximum 6.5mm)

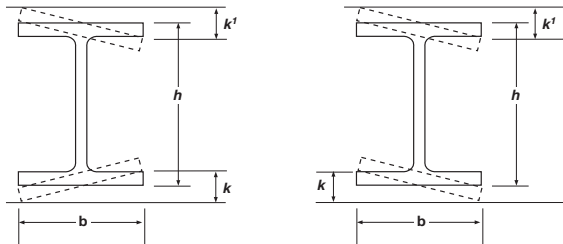

Web off-centre (e)

The mid-thickness of the web shall not deviate from the mid-width position on the flange by more than the distance (e) given in Table 2(b).

Table 2 (b) Tolerance on web off-centre of universal beams and columns

Flange thickness t mm	Flange width b mm	Web off-centre where $e = \frac{b_1 - b_2}{2}$ mm
$t < 40$	Up to and including 110	2.5
	Greater than 110 up to and including 325	3.5
	Greater than 325	5.0
$t \geq 40$	Greater than 110 up to and including 325	5.0
	Greater than 325	8.0

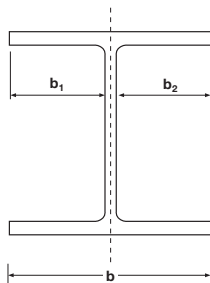

Straightness (q_{xx} or q_{yy})

The straightness shall comply with the requirements given in Table 3.

Table 3 Tolerance on straightness of universal beams and columns

Section height h mm	Tolerance q_{xx} and q_{yy} on length L %
Greater than 80 up to and including 180	0.30 L
Greater than 180 up to and including 360	0.15 L
Greater than 360	0.1 L

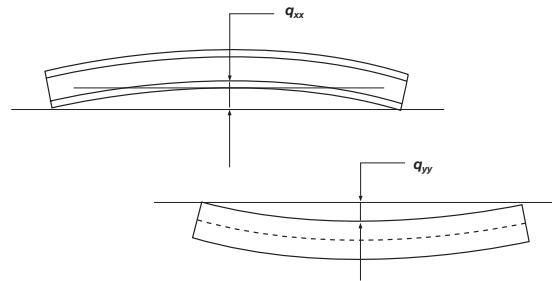

Tolerance on mass

The deviation from the nominal mass of a batch or a piece shall not exceed $\pm 4.0\%$.

The mass deviation is the difference between the actual mass of the batch or piece and the calculated mass. The calculated mass shall be determined using a density of 7850kg/m³.

Tolerance on length

The sections shall be cut to ordered lengths to tolerances of:

- a) $\pm 50\text{mm}$
- or
- b) $-0, +100\text{mm}$ where minimum lengths are required.

L represents the longest useable length of the section assuming that the ends of the section have been cut square.

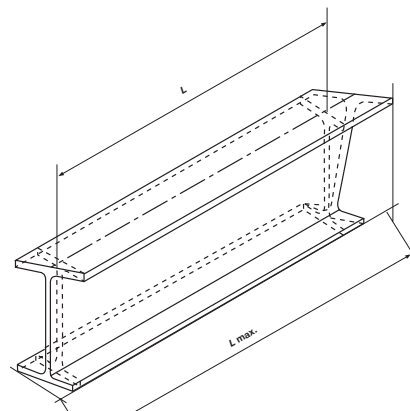

Rolling tolerances – BS EN 10056-2: 1993

This European Standard specifies tolerances on shape dimensions and mass of hot-rolled structural steel equal and unequal leg angles.

Tolerances on shapes and dimensions

Leg length (a or b)

The deviation from nominal on leg length shall be within the tolerance given in Table 1(a). For unequal leg angles the longer leg length (a) shall be used to determine the tolerance band.

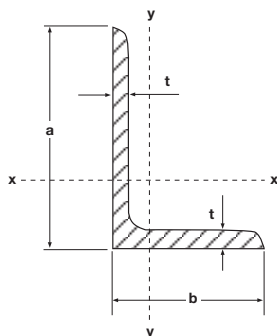

Table 1 (a) Dimensional tolerances

Leg length a mm	Tolerance mm
Up to and including 50	± 1.0
Greater than 50 up to and including 100	± 2.0
Greater than 100 up to and including 150	± 3.0
Greater than 150 up to and including 200	± 4.0
Greater than 200	+ 6.0 -4.0

Section thickness (t)

The deviation from nominal on thickness shall be within the tolerances given in Table 1(b).

Table 1 (b) Thickness tolerances

Section thickness t mm	Tolerance mm
Up to and including 5	± 0.50
Greater than 5 up to and including 10	± 0.75
Greater than 10 up to and including 15	± 1.0
Greater than 15	± 1.20

Out-of-square (k)

Out-of-squareness of the section shall not exceed the maximum given in Table 1(c). For unequal leg angles, the longer leg length (a) shall be used to determine the tolerance band.

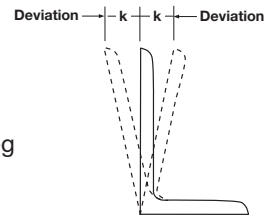

Table 1 (c) Squareness tolerances

Out of square - leg length mm	Tolerance mm
Up to and including 100	1.0
Greater than 100 up to and including 150	1.5
Greater than 150 up to and including 200	2.0
Greater than 200	3.0

Straightness (q)

The deviation from straightness shall not exceed the tolerances given in Table 1(d). For unequal leg angles, the longer leg length (a) shall be used to determine the tolerance band.

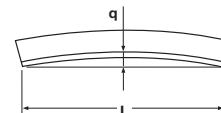

Table 1 (d) Straightness tolerances

Leg length a mm	Tolerance	
	Over full bar length Deviation q mm	Over any part bar length Length considered mm Deviation q mm
Up to and including 150	0.4% L	1,500 6.0
Up to and including 200	0.2% L	2,000 3.0
Greater than 200	0.1% L	3,000 3.0

Tolerance on mass

The deviation from the nominal mass of any individual piece shall not exceed:

- a) ± 6% for thickness for $t \leq 4\text{mm}$ or
- b) ± 4% for thickness for $t > 4\text{mm}$.

The deviation from the nominal mass is the difference between the actual mass of the piece and the calculated mass. The calculated mass shall be determined using a density of 7850kg/m^3 .

Tolerance on length

The tolerance on ordered length shall be either:

- a) ± 50mm; or
- b) -0, +100mm where minimum lengths are required.

Joists to BS 4: Part 1: 1993

Mass tolerances for joists

Tolerances shall be applied to the actual mass per unit length of the joist. The rolling tolerances shall either be:

- a) $\pm 2.5\%$ of the actual mass per unit length
or
b) $+ 5.0\%$ of the actual mass per unit length where a minimum mass per unit length is ordered.

Length tolerances for joists

Joists ordered as "specified" or as "exact" lengths shall be supplied as follows:

- a) *Specified lengths.* When a joist is cut to a specified length, it shall be cut to within $\pm 25\text{mm}$ of that length. When a minimum length is specified, it shall be cut to within $^{+50}_{-0}$ mm of that minimum length.
b) *Exact lengths.* When a section is to be cut to an exact length, it shall be cold sawn to within $\pm 3.2\text{mm}$ of that length.

Depth tolerances for joists

Nominal depth	Maximum permissible variation from specified depth
mm	mm
Up to 305	+3.2 -0.8

Rolling tolerances – BS EN 10279: 2000

This European Standard specifies requirements for the tolerances on dimensions, shape and mass on hot rolled steel channels with parallel flanges.

Table 1: Tolerances for parallel flange channels

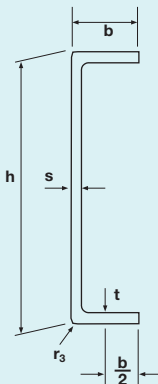
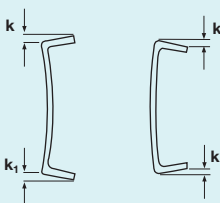
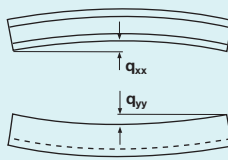
Designation	Property	Range	Tolerance
	mm HEIGHT h	mm h ≤ 65 65 < h ≤ 200 200 < h ≤ 400 400 < h	mm ± 1.5 ± 2.0 ± 3.0 ± 4.0
	FLANGE WIDTH b	b ≤ 50 50 < b ≤ 100 100 < b ≤ 125 125 < b	± 1.5 ± 2.0 ± 2.5 ± 3.0
	WEB THICKNESS s	s ≤ 10 10 < s ≤ 15 15 < s	± 0.5 ± 0.7 ± 1.0
	FLANGE THICKNESS t	t ≤ 10 10 < t ≤ 15 15 < t	a -0.5 a -1.0 a -1.5
	HEEL RADIUS r _s	All Sizes	$\leq 0.3t$
	OUT OF SQUARENESS k + k ₁	b ≤ 100 100 < b	2.0 2.5% of b
	WEB FLATNESS f	h ≤ 100 100 < h ≤ 200 200 < h ≤ 400 400 < h	± 0.5 ± 1.0 ± 1.5 ± 1.5
	STRAIGHTNESS q _{xx}	h ≤ 150 150 < h ≤ 300 300 < h	$\pm 0.3\%$ of L $\pm 0.2\%$ of L $\pm 0.15\%$ of L
	q _{yy}	h ≤ 150 150 < h ≤ 300 300 < h	$\pm 0.5\%$ of L $\pm 0.3\%$ of L $\pm 0.2\%$ of L
STANDARD	LENGTH (L)	All	-0 +100
ALTERNATIVE STANDARD (by agreement)	LENGTH (L)	All	± 50
MASS PER UNIT LENGTH	Kg/m	h ≤ 125 125 < h	$\pm 6\%$ $\pm 4\%$

NB. Plus tolerances are limited by weight